

Archer  
de Boé  
concours qualificatif salle octobre 2024  
salle des archers de Boé, 31-10-2024



Archer: **Merle Mateo**

**1A**

Clubs / Pays: BOE - BOE/Fr

CL U13H

18m-1	Départ: 1						
	1	2	3	Somme	Tot.	10	9
1	9	9	8	26	26		1
2	10 <sup>+</sup>	8	6	24	50	1	
3	8	8	7	23	73		
4	9	8	8	25	98		1
5	9	9	5	23	121		2
6	9	8	7	24	145		1
7	9	9	7	25	170		2
8	10	10	8	28	198	2	
9	10	7	M	17	<del>215</del>	1	<del>M</del>
10	8	7	6	21	236		
<b>Total</b>				236		4	8

Archer

Marqueur

Archer  
de Boé  
concours qualificatif salle octobre 2024  
salle des archers de Boé, 31-10-2024



Archer: **Morillas Capucine**

**1B**

Clubs / Pays: BOE - BOE/Fr

CL U13F

18m-1	Départ: 1						
	1	2	3	Somme	Tot.	10	9
1	9	9	8	26	26		1
2	9	8	M	17	43		1
3	9	8	M	17	60		1
4	10	8	7	25	85	1	
5	9	8	7	24	109		1
6	9	8	7	24	133		1
7	9	9	M	18	151		2
8	8	8	6	22	173		
9	9	7	M	16	189	<del>M</del>	1
10	8	8	M	16	205		
<b>Total</b>				205		1	9

Archer

Marqueur





Archer: **Merle Mateo**

**1A**

Clubs / Pays: BOE - BOE/Fr

CL U13H

18m-2	1	2	3	Départ: 1			
				Somme	Tot.	10	9
1	90	8	7	25	25	1	
2	9	8	7	24	49		1
3	9	9	8	26	75		2
4	9	8	8	25	100		1
5	9	9	8	26	126		2
6	10	10	9	29	155	2	1
7	10	9	8	27	182	1	1
8	9	8	7	24	206		1
9	10	9	8	27	233	1	1
10	9	9	5	23	256		
<b>Total</b>				<b>256</b>			

  
Archer

  
Marqueur



Archer: **Morillas Capucine**

**1B**

Clubs / Pays: BOE - BOE/Fr

CL U13F

18m-2	1	2	3	Départ: 1			
				Somme	Tot.	10	9
1	8	8	7	23	23		
2	9	9	9	27	50		5
3	10	9	9	28	78	1	2
4	9	9	8	26	104		2
5	10	9	7	26	123		
6	9	7	7	23	146		1
7	9	8	8	25	171		1
8	9	9	6	24	195		2
9	9	9	8	26	221		2
10	10	10	10	30	251	3	
<b>Total</b>				<b>251</b>	<b>4</b>	<b>13</b>	

  
Archer

  
Marqueur



concours qualificatif salle octobre 2024  
salle des archers de Boé, 31-10-2024



Archer: **Jagu-Sabathier Mael**

**2A**

Clubs / Pays: BOE - BOE/Fr

CL U13H

18m-1	1	2	3	Départ: 1			
				Somme	Tot.	10	9
1	9	8	8	25	/		1
2	9	8	8	25	50		1
3	8	8	6	22	72		
4	9	9	7	25	97		11
5	10 <sup>+</sup>	9	8	27	124	1	1
6	10	7	3	20	144	1	
7	10 <sup>+</sup>	10 <sup>+</sup>	5	25	169	11	
8	9	7	7	23	192		1
9	10	9	7	26	218	1	1
10	10	10	9	29	247	11	1
<b>Total</b>				<b>247</b>	<b>7</b>	<b>8</b>	

  
Archer

  
Marqueur



concours qualificatif salle octobre 2024  
salle des archers de Boé, 31-10-2024



Archer: **Moreau Aigline**

**2B**

Clubs / Pays: BOE - BOE/Fr

CL U18F

18m-1	1	2	3	Départ: 1			
				Somme	Tot.	10	9
1	9	9	9	27	/		3
2	10	8	4	22	49	1	
3	9	9	8	26	75		11
4	9	8	8	25	100		1
5	8	8	8	24	124		
6	9	9	8	26	150		11
7	10	8	8	26	176	1	
8	9	9	9	27	203		111
9	10	8	7	25	228	1	
10	10 <sup>+</sup>	10	8	28	256	11	
<b>Total</b>				<b>256</b>	<b>5</b>	<b>11</b>	

  
Archer

  
Marqueur



concours qualificatif salle octobre 2024  
salle des archers de Boé, 31-10-2024



Archer: **Jagu-Sabathier Mael**

**2A**

Clubs / Pays: BOE - BOE/Fr

CL U13H

18m-2	1	2	3	Départ: 1			
				Somme	Tot.	10	9
1	9	9	7	25	/		11
2	9	9	7	25	50		11
3	9	9	8	26	76		11
4	9	9	8	26	102		11
5	10	9	7	26	128	1	1
6	9	8	8	25	153		
7	10 <sup>+</sup>	10	9	29	182	11	1
8	10	10	7	27	209	11	
9	10 <sup>+</sup>	8	7	26	235	1	1
10	9	8	8	25	260		1
Total				260	6	12	

Archer

Marqueur



concours qualificatif salle octobre 2024  
salle des archers de Boé, 31-10-2024



Archer: **Moreau Aigline**

**2B**

Clubs / Pays: BOE - BOE/Fr

CL U18F

18m-2	1	2	3	Départ: 1			
				Somme	Tot.	10	9
1	9	8	8	25	/		1
2	9	8	7	24	49		1
3	9	9	8	26	75		11
4	8	7	7	22	97		
5	9	8	6	23	120		1
6	9	8	7	24	144		1
7	9	8	8	25	169		1
8	9	7	7	23	192		1
9	9	8	6	23	215		1
10	9	8	8	25	240		1
Total				240	1	10	

Archer

Marqueur



concours qualificatif salle octobre 2024  
salle des archers de Boé, 31-10-2024



Archer: **De Flaujac Mayeul**

**3A**

Clubs / Pays: BOE - BOE/Fr

CL U15H

18m-1	1	2	3	Départ: 1			
				Somme	Tot.	10	9
1	9	9	8	26			2
2	9	9	3	21	47		2
3	9	9	8	26	73		2
4	9	8	8	25	98		1
5	9	9	9	27	125		3
6	9	8	8	25	150		1
7	8	8	8	24	174		
8	10	9	9	28	202	1	2
9	10	10	8	28	230	2	
10	10	10	9	29	259	2	1
<b>Total</b>				<b>259</b>	<b>5</b>	<b>14</b>	

*Mayeul*  
Archer

*[Signature]*  
Marqueur



concours qualificatif salle octobre 2024  
salle des archers de Boé, 31-10-2024



Archer: **Hedoux Francis**

**3B**

Clubs / Pays: VILLENEUVE - Villeneuve Sur Lot/Fr

CO S2H

18m-1	1	2	3	Départ: 1			
				Somme	Tot.	10	9
1	9	8	M	17			1
2	9	9	8	26	43		2
3	10	9	8	27	70	1	1
4	10	10	8	28	98	2	
5	10	9	9	28	126	1	2
6	10	9	9	28	154	1	2
7	10	9	9	28	182	1	2
8	10	9	7	26	208	1	1
9	10	10	9	29	237	2	1
10	9	9	9	27	264		3
<b>Total</b>				<b>264</b>	<b>9</b>	<b>15</b>	

*[Signature]*  
Archer

*Mayeul*  
Marqueur



concours qualificatif salle octobre 2024  
salle des archers de Boé, 31-10-2024



Archer: **De Flaujac Mayeul**

**3A**

Clubs / Pays: BOE - BOE/Fr

CL U15H

18m-2	1	2	3	Départ: 1			
				Somme	Tot.	10	9
1	9	8	7	24			1
2	9	9	9	27	51		3
3	9	9	8	26	77		2
4	10	9	9	28	105	1	2
5	9	8	7	24	129		1
6	10	9	8	27	156	1	1
7	10	9	8	27	183	1	1
8	10	10	8	28	211	2	
9	10	9	7	26	237	1	1
10	9	9	8	26	263		2
<b>Total</b>				<b>263</b>	<b>6</b>	<b>14</b>	

*Mayeul*  
Archer

*[Signature]*  
Marqueur



concours qualificatif salle octobre 2024  
salle des archers de Boé, 31-10-2024



Archer: **Hedoux Francis**

**3B**

Clubs / Pays: VILLENEUVE - Villeneuve Sur Lot/Fr

CO S2H

18m-2	1	2	3	Départ: 1			
				Somme	Tot.	10	9
1	9	9	9	27			3
2	9	8	7	24	51		1
3	10	10	9	29	80	2	1
4	9	8	<del>7</del> 8	25	105		1
5	10	10	8	28	133	2	
6	9	9	9	27	160		3
7	10	9	9	28	188	1	2
8	10	9	9	28	216	1	2
9	10	10	9	29	245	2	1
10	10	10	9	29	274	2	1
<b>Total</b>				<b>274</b>	<b>10</b>	<b>15</b>	

*[Signature]*  
Archer

*Mayeul*  
Marqueur





**concours qualificatif salle octobre 2024**  
salle des archers de Boé, 31-10-2024



Archer: **Galli Eloise**

**4A**

Clubs / Pays: **BOE - BOE/Fr**

**CL U15F**

18m-1	1	2	3	Départ: 1			
				Somme	Tot.	10	9
1	7	7	6	20			
2	7	M	M	7	27		
3	7	M	M	7	34		
4	8	7	6	21	55		
5	8	7	6	21	76		
6	10	9	M	19	95	1	1
7	8	8	M	16	111		
8	8	M	M	8	119		
9	8	M	M	8	127		
10	10	9	7	26	153	1	1
<b>Total</b>				<b>153</b>	<b>2</b>	<b>2</b>	

Archer

Marqueur



**concours qualificatif salle octobre 2024**  
salle des archers de Boé, 31-10-2024



Archer: **Nicolas Olivier**

**4B**

Clubs / Pays: **AUCH - Auch/fr**

**CO S2H**

18m-1	1	2	3	Départ: 1			
				Somme	Tot.	10	9
1	9	9	9	27			3
2	10	9	9	28	55	1	2
3	10	9	8	27	82	1	1
4	10	10	9	29	111	2	1
5	10	9	9	28	139	1	2
6	9	9	9	27	166		3
7	9	9	8	26	192		2
8	9	9	9	27	219		3
9	10	10	9	29	248	2	1
10	10	9	9	28	276	1	2
<b>Total</b>				<b>276</b>	<b>8</b>	<b>20</b>	

Archer

Marqueur



**concours qualificatif salle octobre 2024**  
salle des archers de Boé, 31-10-2024



Archer: **Galli Eloise**

**4A**

Clubs / Pays: **BOE- BOE/Fr**

**CL U15F**

18m-2	1	2	3	Départ: 1			
				Somme	Tot.	10	9
1	10	8	7	25		1	
2	10	8	11	18	43	1	
3	9	6	11	15	58		1
4	9	9	7	25	83		2
5	9	9	8	26	109		2
6	8	7	6	21	130		
7	8	8	7	23	153		
8	9	9	7	25	178		2
9	10	10	6	26	204	2	
10	9	7	6	22	226		1
<b>Total</b>				<b>226</b>	<b>4</b>	<b>8</b>	

Archer

Marqueur



**concours qualificatif salle octobre 2024**  
salle des archers de Boé, 31-10-2024



Archer: **Nicolas Olivier**

**4B**

Clubs / Pays: **AUCH- Auch/fr**

**CO S2H**

18m-2	1	2	3	Départ: 1			
				Somme	Tot.	10	9
1	8	7	7	22			
2	10	10	9	29	51	2	1
3	10	9	9	28	79	1	2
4	9	9	9	27	106		3
5	10	9	9	28	134	1	2
6	10	10	9	29	163	2	1
7	10	9	9	28	191	1	2
8	10	10	9	29	220	2	1
9	9	9	9	27	247		3
10	10	9	6	25	272	1	1
<b>Total</b>				<b>272</b>	<b>10</b>	<b>16</b>	

Archer

Marqueur





concours qualificatif salle octobre 2024  
salle des archers de Boé, 31-10-2024



Archer: **Papini Nerio**

**5A**

Clubs / Pays: BOE - BOE/Fr

CL U15H

18m-1	1	2	3	Départ: 1			
				Somme	Tot.	10	9
1	10	8	7	25		1	
2	9	9	8	26	51		2
3	9	8	8	25	76		1
4	10	9	8	27	103	1	1
5	9	8	8	25	128		1
6	9	9	8	26	154		2
7	8	8	6	22	176		
8	10	9	8	27	203	1	1
9	8	8	7	23	226		
10	9	9	5	23	249		2
				<b>Total</b>	<b>249</b>	<b>3</b>	<b>10</b>

0047512U-CL-U15H-1

Papini Nerio  
Archer

Anna  
Marqueur



concours qualificatif salle octobre 2024  
salle des archers de Boé, 31-10-2024



Archer: **Nicolas Anna**

**5B**

Clubs / Pays: AUCH - Auch/fr

CO U15F

18m-1	1	2	3	Départ: 1			
				Somme	Tot.	10	9
1	9	9	9	27			3
2	9	8	7	24	51		1
3	9	9	M	18	69		2
4	10	8	8	26	95	1	
5	7	7	M	14	109		
6	9	9	9	27	136		3
7	9	9	7	25	161		2
8	9	9	6	24	185		2
9	8	6	M	14	199		
10	9	8	M	17	216		1
				<b>Total</b>	<b>216</b>	<b>1</b>	<b>14</b>

0981534K-CO-U15F-1

Anna  
Archer

Papini Nerio  
Marqueur





concours qualificatif salle octobre 2024  
salle des archers de Boé, 31-10-2024



Archer: **Papini Nerio**

**5A**

Clubs / Pays: BOE - BOE/Fr

CL U15H

18m-2	1	2	3	Départ: 1			
				Somme	Tot.	10	9
1	10	9	8	27		1	1
2	9	8	7	24	51		1
3	9	9	9	27	78		3
4	9	9	4	22	100		2
5	10	8	7	25	125	1	
6	9	9	6	24	149		2
7	10	8	5	23	172	1	
8	8	7	4	19	191		
9	10	9	8	22	218	1	1
10	9	9	7	25	243		2
<b>Total</b>				<b>243</b>	<b>4</b>	<b>12</b>	

Papini Nerio  
Archer

  
Marqueur



concours qualificatif salle octobre 2024  
salle des archers de Boé, 31-10-2024



Archer: **Nicolas Anna**

**5B**

Clubs / Pays: AUCH - Auch/fr

CO U15F

18m-2	1	2	3	Départ: 1			
				Somme	Tot.	10	9
1	8	8	6	22			
2	8	8	7	23	45		
3	8	7	8	22	67		
4	8	7	6	21	88		
5	9	7	M	16	104		1
6	10	7	7	24	128	1	
7	9	8	7	24	152		1
8	9	8	6	23	175		1
9	9	9	8	26	201		2
10	10	8	6	24	225	1	
<b>Total</b>				<b>225</b>	<b>2</b>	<b>5</b>	

  
Archer

Papini Nerio  
Marqueur



Archer  
  
**concours qualificatif salle octobre 2024**  
 salle des archers de Boé, 31-10-2024



Archer: **Sensamat Timeo**

**6A**

Clubs / Pays: BOE - BOE/Fr

CL U11H

18m-1	1	2	3	Départ: 1			
				Somme	Tot.	10	9
1	9	8	8	25			
2	10	10	10	30	55		
3	10	9	6	25	80		
4	10	8	7	25	105		
5	10	9	7	26	131		
6	9	9	9	27	158		
7	9	8	7	24	182		
8	10	8	8	26	208		
9	9	8	7	24	232		
10	10	9	9	28	260		
<b>Total</b>				<b>260</b>			

  
 Archer

  
 Marqueur

Archer  
  
**concours qualificatif salle octobre 2024**  
 salle des archers de Boé, 31-10-2024



Archer: **Nicollas Clement**

**6B**

Clubs / Pays: BOE - BOE/Fr

CL U11H

18m-1	1	2	3	Départ: 1			
				Somme	Tot.	10	9
1	7	5	4	16			
2	6	6	5	17	33		
3	8	5	5	18	51		
4	9	8	7	24	75		
5	9	8	3	20	95		
6	8	8	6	22	117		
7	8	8	7	23	140		
8	9	8	5	22	162		
9	8	6	3	17	179		
10	7	4	3	14	193		
<b>Total</b>				<b>193</b>			

  
 Archer

  
 Marqueur





concours qualificatif salle octobre 2024  
salle des archers de Boé, 31-10-2024



Archer: **Sensamat Timeo**

**6A**

Clubs / Pays: BOE- BOE/Fr

CL U11H

18m-2	1	2	3	Départ: 1			
				Somme	Tot.	10	9
1	9	7	5	21			
2	10	9	7	26	47		
3	10	9	7	26	73		
4	10	9	8	27	100		
5	9	8	7	24	124		
6	10	9	9	28	152		
7	10	9	8	27	179		
8	10	8	8	26	205		
9	9	9	8	27	232		
10	8	8	8	24	256		
<b>Total</b>				<b>256</b>	<b>516</b>		

Archer

Marqueur **Clement**



concours qualificatif salle octobre 2024  
salle des archers de Boé, 31-10-2024



Archer: **Nicollas Clement**

**6B**

Clubs / Pays: BOE- BOE/Fr

CL U11H

18m-2	1	2	3	Départ: 1			
				Somme	Tot.	10	9
1	9	7	7	23			
2	5	1	M	6	29		
3	9	8	3	20	49		
4	8	7	3	18	67		
5	6	3	3	12	79		
6	8	3	1	12	89		
7	8	7	1	16	105		
8	7	4	4	15	117		
9	8	7	6	21	138		
10	9	4	2	15	153		
<b>Total</b>				<b>193</b>	<b>346</b>		

Archer **Clement**

Marqueur





concours qualificatif salle octobre 2024  
salle des archers de Boé, 31-10-2024



Archer: **Cedo Julie**

**7A**

Clubs / Pays: BOE - BOE/Fr

CL U18F

18m-1	1	2	3	Départ: 1			
				Somme	Tot.	10	9
1	10	8	4	22		1	
2	8	8	7	23	45		
3	10	9	9	28	73	1	2
4	10	8	6	24	97	1	
5	10	7	3	20	117	1	
6	7	7	5	19	136		
7	8	8	8	24	160		
8	9	8	7	24	184		1
9	10	8	6	24	208	1	
10	9	8	7	25	233		2
<b>Total</b>				<b>233</b>	<b>5</b>	<b>5</b>	

Archer

Marqueur



concours qualificatif salle octobre 2024  
salle des archers de Boé, 31-10-2024



Archer: **Laforgue Yvon**

**7B**

Clubs / Pays: BOE - BOE/Fr

CL U18H

18m-1	1	2	3	Départ: 1			
				Somme	Tot.	10	9
1	7	7	7	21			
2	9	8	11	28	38		1
3	9	7	6	22	60		1
4	7	6	11	24	73		
5	9	8	11	28	90		1
6	10	7	7	24	114	1	
7	9	8	8	25	139		1
8	7	7	11	25	153		
9	8	7	11	26	169		1
10	8	8	11	27	185		
<b>Total</b>				<b>185</b>	<b>7</b>	<b>5</b>	

Archer

Marqueur





**concours qualificatif salle octobre 2024**  
salle des archers de Boé, 31-10-2024



Archer: **Cedo Julie**

**7A**

Clubs / Pays: BOE - BOE/Fr

CL U18F

18m-2	1	2	3	Départ: 1			
				Somme	Tot.	10	9
1	70	8	7	26		7	
2	70	7	7	26	53	7	
3	70	7	6	23	75	7	
4	9	7	7	23	98		7
5	9	7	7	24	722		7
6	9	9	8	26	748		2
7	9	8	6	23	777		7
8	76	9	8	27	797	7	7
9	9	7	7	23	227		7
10	9	7	7	23	244		7
<b>Total</b>				<b>244</b>	<b>48</b>		

  
Archer

  
Marqueur



**concours qualificatif salle octobre 2024**  
salle des archers de Boé, 31-10-2024



Archer: **Laforgue Yvon**

**7B**

Clubs / Pays: BOE - BOE/Fr

CL U18H

18m-2	1	2	3	Départ: 1			
				Somme	Tot.	10	9
1	7	7	7	21			
2	8	7	7	22	29		
3	70	9	6	25	54	7	7
4	9	8	7	24	78		7
5	9	7	7	23	707		7
6	7	6	7	20	774		
7	70	70	7	20	734	2	
8	70	8	6	24	73	7	
9	70	7	6	23	787	7	
10	70	9	9	28	209	7	2
<b>Total</b>				<b>209</b>	<b>65</b>		

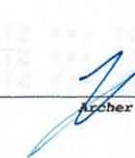
  
Archer

  
Marqueur



concours qualificatif salle octobre 2024  
salle des archers de Boé, 31-10-2024



Archer: **Filhastre Lucie**

**8A**

Clubs / Pays: BOE - BOE/Fr

CL U18F

18m-1	1	2	3	Départ: 1			
				Somme	Tot.	10	9
1	10	9	9	28	28	1	2
2	10	9	7	26	54	1	1
3	10	10	8	28	82	2	/
4	10	9	9	28	110	1	2
5	10	9	9	28	138	1	2
6	10	10	9	29	167	2	1
7	10	9	9	28	195	1	2
8	10	9	9	28	223	1	2
9	10	9	9	28	251	1	2
10	9	9	9	27	278	/	3
<b>Total</b>				278	M	17	

  
Archer

  
Marqueur





concours qualificatif salle octobre 2024  
salle des archers de Boé, 31-10-2024



Archer: **Jean Mickaël**

**8B**

Clubs / Pays: MUEL - MUEL/fr

CL S2H

18m-1	1	2	3	Départ: 1			
				Somme	Tot.	10	9
1	5	5	4	14	14		
2	M	M	M	0	14		
3	9	6	1	16	30		
4	10	7	6	23	53	1	
5	6	5	2	13	66		
6	7	3	1	11	77		
7	8	4	M	12	89		
8	8	6	6	20	109		
9	8	6	1	15	124		
10	6	6	3	17	141		
<b>Total</b>				141	110		

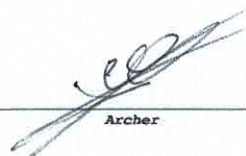
  
Archer

  
Marqueur



**concours qualificatif salle octobre 2024**  
salle des archers de Boé, 31-10-2024



Archer: **Filhastre Lucie**

**8A**

Clubs / Pays: BOE - BOE/Fr

CL U18F

18m-2	1	2	3	Départ: 1			
				Somme	Tot.	10	9
1	10	9	8	27	27	1	1
2	10	10	9	29	56	2	1
3	10	9	9	28	84	1	2
4	10	9	8	27	111	1	1
5	10	9	7	26	137	1	1
6	10	10	9	29	166	2	1
7	9	9	8	26	192	1	2
8	10	10	9	29	221	2	1
9	10	9	9	28	249	1	2
10	10	9	8	27	276	1	1
<b>Total</b>				<b>276</b>	<b>1213</b>		

  
Archer

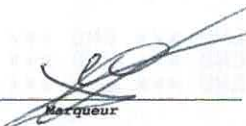
  
Marqueur



**concours qualificatif salle octobre 2024**  
salle des archers de Boé, 31-10-2024



Archer: **Jean Michael**

**8B**

Clubs / Pays: MUEL - MUEL/fr

CL S2H

18m-2	1	2	3	Départ: 1			
				Somme	Tot.	10	9
1	5	4	3	12	12		
2	6	5	4	15	27		
3	7	5	3	15	42		
4	8	8	2	18	60		
5	6	4	4	14	74		
6	8	8	3	23	97		
7	9	8	5	22	119		1
8	9	8	M	17	136		1
9	10	8	7	25	161	1	
10	9	3	M	12	173		1
<b>Total</b>				<b>173</b>	<b>113</b>		

  
Archer

  
Marqueur







concours qualificatif salle octobre 2024  
salle des archers de Boé, 31-10-2024



Archer: **Dumont Aurelien**

**9A**

Clubs / Pays: BOE - BOE/fr

CL U21H

18m-2	1	2	3	Départ: 1			
				Somme	Tot.	10	9
1	10	9	9	28	1	1	2
2	9	8	11	17	45	1	1
3	10	10	9	29	74	2	1
4	9	9	9	27	101	1	3
5	10	9	9	28	129	1	2
6	10	9	9	28	157	1	2
7	9	9	8	26	183	1	2
8	10	10	9	29	212	2	1
9	10	9	9	28	240	1	2
10	10	10	9	29	269	2	1
<b>Total</b>				269	10	18	

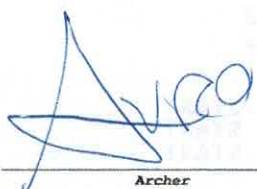
  
Archer

  
Marqueur



concours qualificatif salle octobre 2024  
salle des archers de Boé, 31-10-2024



Archer: **Jean Maxime**

**9B**

Clubs / Pays: MUEL - MUEL/fr

CL U21H

18m-2	1	2	3	Départ: 1			
				Somme	Tot.	10	9
1	9	9	7	25	1	1	2
2	9	4	2	15	40	1	1
3	9	8	6	23	63	1	1
4	8	7	4	19	82	1	1
5	8	8	7	23	105	1	1
6	8	8	7	23	128	1	1
7	9	9	7	25	153	1	2
8	9	8	7	24	177	1	1
9	10	9	5	24	201	1	1
10	9	8	7	24	225	1	1
<b>Total</b>				225	1	9	

  
Archer

  
Marqueur





**concours qualificatif salle octobre 2024**  
salle des archers de Boé, 31-10-2024



Archer: **Dumont Aurelien**

**9A**

Clubs / Pays: **BOE - BOE/fr**

**CL U21H**

18m-1	1	2	3	Départ: 1			
				Somme	Tot.	10	9
1	10	9	M	19	/	1	1
2	10	9	9	28	47	1	2
3	10	10	9	29	76	2	1
4	10	10	9	29	105	2	1
5	9	9	9	27	132	1	3
6	10	10	9	29	161	2	1
7	9	7	6	22	183	1	9
8	10	10	8	28	211	2	1
9	10	9	8	27	238	1	1
10	10	10	6	26	264	2	1
<b>Total</b>				<b>264</b>	<b>192</b>	<b>11</b>	

  
Archer

  
Marqueur



**concours qualificatif salle octobre 2024**  
salle des archers de Boé, 31-10-2024



Archer: **Jean Maxime**

**9B**

Clubs / Pays: **MUEL - MUEL/fr**

**CL U21H**

18m-1	1	2	3	Départ: 1			
				Somme	Tot.	10	9
1	8	8	7	23	/	1	1
2	10	9	4	23	46	1	1
3	8	6	5	19	65	1	1
4	7	6	2	15	80	1	1
5	9	7	4	20	100	1	1
6	7	7	5	19	119	1	1
7	9	8	7	24	143	1	1
8	10	10	7	27	170	2	1
9	10	9	9	28	198	1	2
10	9	8	8	25	223	1	1
<b>Total</b>				<b>223</b>	<b>4</b>	<b>6</b>	

  
Archer

  
Marqueur





concours qualificatif salle octobre 2024  
salle des archers de Boé, 31-10-2024



Archer: **Sirben Elorri**

**10A**

Clubs / Pays: BOE - BOE/Fr

CL U21F

18m-1	1	2	3	Départ: 1			
				Somme	Tot.	10	9
1	9	7	6	22	1		1
2	9	5	5	19	41		1
3	10	9	8	27	68	1	1
4	10	9	8	27	95	1	1
5	10	9	7	26	121	1	1
6	9	8	8	25	146		1
7	10	10	8	28	174	2	
8	9	8	6	23	197		1
9	7	5	5	17	214		
10	10	7	6	23	237	1	
<b>Total</b>				<b>237</b>	<b>6</b>	<b>7</b>	

Archer

Marqueur



concours qualificatif salle octobre 2024  
salle des archers de Boé, 31-10-2024



Archer: **Daste Alain**

**10B**

Clubs / Pays: BOE - BOE/Fr

CO S3H

18m-1	1	2	3	Départ: 1			
				Somme	Tot.	10	9
1	9	8	8	25	1		1
2	10	8	7	25	50	1	
3	9	9	9	27	77		3
4	9	9	9	27	104		3
5	9	8	8	25	129	1	2
6	10	9	7	26	155	1	1
7	9	9	8	26	181		2
8	10	9	8	27	208	1	1
9	10	9	9	28	236	1	2
10	10	9	8	27	263	1	1
<b>Total</b>				<b>263</b>	<b>5</b>	<b>16</b>	

Archer

Marqueur





concours qualificatif salle octobre 2024  
salle des archers de Boé, 31-10-2024



Archer: **Sirben Elorri**

**10A**

Clubs / Pays: BOE - BOE/Fr

CL U21F

18m-2	1	2	3	Départ: 1			
				Somme	Tot.	10	9
1	10	8	8	26	1	1	
2	9	8	6	23	49		1
3	9	9	6	24	73		2
4	9	9	8	26	99		2
5	9	8	5	22	121		1
6	9	8	8	25	146		1
7	9	9	8	26	172		2
8	9	8	8	25	197		1
9	9	9	7	25	222		2
10	8	8	6	22	244		
<b>Total</b>				244	1	12	

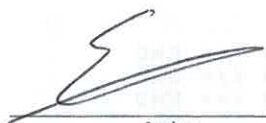
  
Archer

  
Marqueur



concours qualificatif salle octobre 2024  
salle des archers de Boé, 31-10-2024



Archer: **Daste Alain**

**10B**

Clubs / Pays: BOE - BOE/Fr

CO S3H

18m-2	1	2	3	Départ: 1			
				Somme	Tot.	10	9
1	9	8	8	25	1		1
2	9	9	8	26	51		2
3	10	9	9	28	79	1	2
4	9	9	8	26	105		2
5	9	9	7	25	130		2
6	10	8	7	25	155	1	
7	10	9	8	27	182	1	1
8	10	10	9	29	211	2	1
9	9	9	8	26	237		2
10	9	9	8	26	263		2
<b>Total</b>				263	5	15	

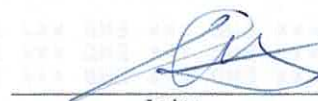
  
Archer

  
Marqueur



Archeirs de Boé  
**concours qualificatif salle octobre 2024**  
 salle des archers de Boé, 31-10-2024



Archer: **RoumeGas Leslie**

**11A**

Clubs / Pays: BOE - BOE/Fr

CL U18F

18m-1	1	2	3	Départ: 1			
				Somme	Tot.	10	9
1	7	6	6	19	✓	✓	✓
2	7	6	6	19	38	✓	✓
3	8	6	3	17	55	✓	✓
4	7	<del>7</del>	5	19	74	✓	✓
5	9	8	8	25	99	✓	1
6	8	7	3	18	117	✓	✓
7	5	5	2	12	129	✓	✓
8	7	5	4	16	141	✓	✓
9	9	7	6	22	163	✓	1
10	7	7	4	18	181	✓	✓
<b>Total</b>				<b>181</b>	✓	✓	✓

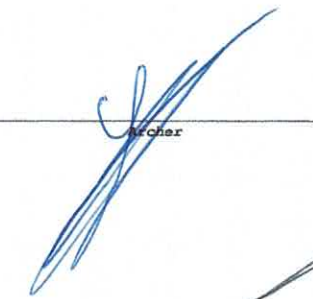
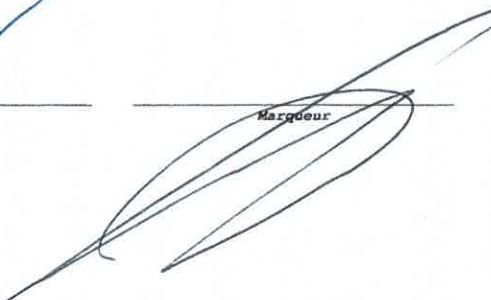
Archer:   
 Marqueur: 

Archeirs de Boé  
**concours qualificatif salle octobre 2024**  
 salle des archers de Boé, 31-10-2024



Archer: **Nicolas Adrien**

**11B**

Clubs / Pays: NEUILLY - NEUILLY SUR MARNE/Fr

CO S1H

18m-1	1	2	3	Départ: 1			
				Somme	Tot.	10	9
1	10	10	9	29	✓	2	1
2	<del>10</del>	<del>10</del>	10	30	59	3	✓
3	10	10	10	30	89	3	✓
4	10	9	9	28	117	1	2
5	10	10	9	29	146	2	1
6	10	9	9	28	174	1	2
7	10	9	9	28	202	1	2
8	10	10	9	29	231	2	1
9	10	10	9	29	260	2	1
10	10	10	9	29	289	2	1
<b>Total</b>				<b>289</b>	19	11	✓

*6vs*

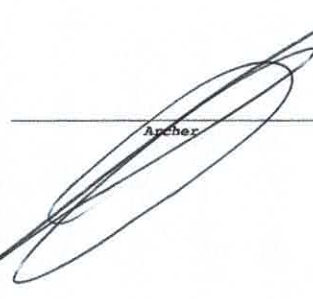
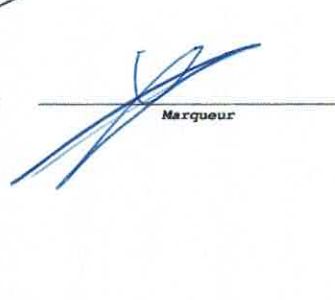
Archer:   
 Marqueur: 





**concours qualificatif salle octobre 2024**  
salle des archers de Boé, 31-10-2024



Archer: **Roume gas Leslie**

**11A**

Clubs / Pays: BOE - BOE/Fr

CL U18F

18m-2	1	2	3	Départ: 1			
				Somme	Tot.	10	9
1	9	7	6	22	-	-	1
2	10	7	7	24	46	1	1
3	8	8	4	20	66	-	-
4	8	5	4	17	83	-	-
5	7	6	5	18	101	-	-
6	6	5	5	16	117	-	-
7	8	6	2	16	133	-	-
8	10	7	7	24	157	1	1
9	10	8	6	24	181	1	1
10	8	8	6	22	203	-	-
<b>Total</b>				<b>203</b>	<b>3</b>	<b>1</b>	

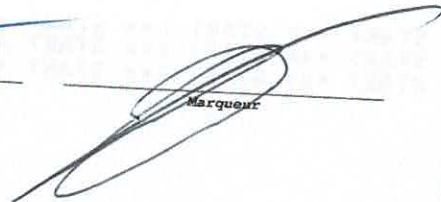
 Archer  
 Marqueur



**concours qualificatif salle octobre 2024**  
salle des archers de Boé, 31-10-2024



Archer: **Nicolas Adrien**

**11B**

Clubs / Pays: NEULLY - NEULLY SUR MARNE/Fr

CO S1H

18m-2	1	2	3	Départ: 1			
				Somme	Tot.	10	9
1	10	10	9	29	-	2	1
2	10	10	10	30	59	3	1
3	10	<del>10</del>	9	28	87	1	2
4	10	9	9	28	115	1	2
5	10	10	9	29	145	2	1
6	10	10	10	30	175	3	1
7	10	10	9	29	204	2	1
8	10	10	9	29	233	2	1
9	10	10	9	29	262	2	1
10	10	10	9	29	291	2	1
<b>Total</b>				<b>291</b>	<b>21</b>	<b>9</b>	

 Archer  
 Marqueur





Archer: **Cedo Ruben**

**12A**

Clubs / Pays: BOE - BOE/Fr

CL U13H

18m-1	1	2	3	Départ: 1			
				Somme	Tot.	10	9
1	10	9	8	27	27	1	1
2	7	7	7	24	51	1	0
3	10	8	8	26	77	1	0
4	10	9	9	28	105	1	2
5	8	8	7	23	128	0	0
6	9	9	7	25	153	0	2
7	10	10	7	27	180	2	0
8	8	8	8	24	204	0	0
9	8	7	6	21	225	0	0
10	10	9	8	27	252	1	1
<b>Total</b>				<b>252</b>	<b>7</b>	<b>8</b>	

  
Archer

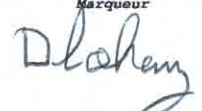
  
Marqueur



Archer: **Derteil Combalbert Lohan**

**12B**

Clubs / Pays: ST MAURE - Ste Maure De Peyriac/fr

CL U15H

18m-1	1	2	3	Départ: 1			
				Somme	Tot.	10	9
1	9	8	6	23	23	0	1
2	9	8	8	25	48	0	1
3	10	9	8	27	75	1	1
4	9	8	6	23	98	0	1
5	8	6	9	18	116	0	0
6	10	8	6	24	140	1	0
7	10	9	7	26	166	1	1
8	8	7	5	20	186	0	0
9	10	10	10	30	216	3	0
10	9	8	6	23	239	0	1
<b>Total</b>				<b>239</b>	<b>6</b>	<b>6</b>	

  
Archer

  
Marqueur

Archerie concours qualificatif salle octobre 2024  
salle des archers de Boé, 31-10-2024



Archer: **Cedo Ruben**

**12A**

Clubs / Pays: BOE - BOE/Fr

CL U13H

18m-2	1	2	3	Départ: 1			
				Somme	Tot.	10	9
1	10	9	8	27	27	1	1
2	9	9	8	26	53	0	2
3	10	10	9	29	82	2	1
4	10	9	9	28	110	1	2
5	10	10	8	28	138	2	0
6	9	8	7	24	162	0	1
7	10	9	8	27	189	1	1
8	10	9	6	25	214	1	1
9	10	9	8	27	241	1	1
10	10	10	8	28	269	2	0
<b>Total</b>				<b>269</b>	<b>1170</b>		

Archer

Marqueur

Archerie concours qualificatif salle octobre 2024  
salle des archers de Boé, 31-10-2024



Archer: **Derteil Combalbert Lohan**

**12B**

Clubs / Pays: ST MAURE - Ste Maure De Peyriac/fr

CL U15H

18m-2	1	2	3	Départ: 1			
				Somme	Tot.	10	9
1	10	9	7	26	26	1	1
2	10	7	5	22	48	1	0
3	8	8	6	22	70	0	0
4	9	7	6	22	92	0	1
5	8	8	7	23	115	0	0
6	9	6	5	20	135	0	1
7	9	8	7	24	159	0	1
8	9	8	5	22	181	0	1
9	9	5	5	19	200	0	1
10	9	8	6	23	223	0	1
<b>Total</b>				<b>223</b>	<b>2</b>	<b>7</b>	

Archer

Marqueur





concours qualificatif salle octobre 2024  
salle des archers de Boé, 31-10-2024



Archer: **Bonneau Pierre**

**13A**

Clubs / Pays: STE MAURE - Ste Maure De Peyriac/Fr

CO S3H

18m-1	1	2	3	Départ: 1			
				Somme	Tot.	10	9
1	9	8	8	25	25		1
2	9	9	9	27	52		3
3	9	9	9	27	79		3
4	9	9	9	27	106		3
5	10	9	8	27	133	1	1
6	9	9	7	25	158		2
7	10	9	8	27	185	1	1
8	10	9	9	28	213	1	2
9	9	9	9	27	240		3
10	9	9	9	27	267		3
<b>Total</b>				267	3	22	

Archer

Marqueur



concours qualificatif salle octobre 2024  
salle des archers de Boé, 31-10-2024



Archer: **Coppola Matheo**

**13B**

Clubs / Pays: BOE - BOE/Fr

CL U13H

18m-1	1	2	3	Départ: 1			
				Somme	Tot.	10	9
1	8	7	6	21	21		
2	9	9	6	24	45		2
3	10	8	7	25	70	1	
4	9	6	6	21	91		1
5	10	8	7	25	116	1	
6	9	8	6	23	139		1
7	8	8	7	23	162		
8	10	9	7	26	188	1	1
9	10	9	7	26	214	1	1
10	10	8	6	24	238	1	
<b>Total</b>				238	5	6	

Archer

Marqueur



concours qualificatif salle octobre 2024  
salle des archers de Boé, 31-10-2024



Archer: **Bonneau Pierre**

**13A**

Clubs / Pays: STE MAURE - Ste Maure De Peyriac/Fr

CO S3H

18m-2	1	2	3	Départ: 1			
				Somme	Tot.	10	9
1	9	9	7	25	25		2
2	10	9	9	28	53	1	2
3	9	9	9	27	80		3
4	10	9	7	26	106	1	1
5	9	9	8	26	132		2
6	9	9	9	27	159		3
7	9	9	9	27	186		3
8	9	9	7	25	211		2
9	9	9	8	26	237		2
10	9	9	9	27	264		3
<b>Total</b>				<b>264</b>	<b>2</b>	<b>23</b>	

  
Archer

  
Marqueur



concours qualificatif salle octobre 2024  
salle des archers de Boé, 31-10-2024



Archer: **Coppola Matheo**

**13B**

Clubs / Pays: BOE - BOE/Fr

CL U13H

18m-2	1	2	3	Départ: 1			
				Somme	Tot.	10	9
1	8	8	5	21	21		
2	10	8	7	25	46	1	
3	8	8	7	23	69		
4	9	7	7	23	92		1
5	9	9	5	23	115		2
6	9	9	8	26	141		2
7	9	9	8	26	167		2
8	10	6	6	22	189	1	
9	9	8	7	24	213		1
10	10	9	9	28	241	1	2
<b>Total</b>				<b>241</b>	<b>3</b>	<b>10</b>	

  
Archer

  
Marqueur





concours qualificatif salle octobre 2024  
salle des archers de Boé, 31-10-2024



Archer: **Demageaux Jean**

**14A**

Clubs / Pays: **JUSSY - JUSSY/Fr**

**CL S3H**

18m-1	1	2	3	Départ: 1			
				Somme	Tot.	10	9
1	10	9	6	25		1	1
2	10	8	6	24	49	1	
3	10	7	7	24	73	1	
4	9	9	8	26	99		3
5	9	8	8	25	124		1
6	10	8	7	25	149	1	
7	9	9	7	26	175		2
8	10	10	8	28	203	2	
9	9	9	8	26	229		2
10	10	9	8	27	256	1	1
<b>Total</b>				<b>256</b>		<b>7</b>	<b>10</b>

Archer

Marqueur



concours qualificatif salle octobre 2024  
salle des archers de Boé, 31-10-2024



Archer: **Pichayrou-Laforgue Celine**

**14B**

Clubs / Pays: **BOE - BOE/Fr**

**CO S2F**

18m-1	1	2	3	Départ: 1			
				Somme	Tot.	10	9
1	10	9	9	28		1	2
2	9	8	8	25	53		1
3	10	10	9	29	82	2	1
4	9	9	9	27	109		3
5	10	9	9	28	137	1	2
6	9	9	7	26	163		2
7	9	8	8	25	188		1
8	9	9	9	27	215		3
9	10	9	9	28	243	1	2
10	10	9	7	26	269	1	1
<b>Total</b>				<b>269</b>		<b>6</b>	<b>18</b>

Archer

Marqueur



concours qualificatif salle octobre 2024  
salle des archers de Boé, 31-10-2024



Archer: **Demageaux Jean**

**14A**

Clubs / Pays: **JUSSY - JUSSY/Fr**

**CL S3H**

18m-2	1	2	3	Départ: 1			
				Somme	Tot.	10	9
1	10	9	7	26		1	1
2	9	9	9	27	53		3
3	9	8	6	23	76		1
4	10	10	9	29	105	2	1
5	9	9	7	25	130		2
6	8	8	8	24	154		
7	8	8	5	21	175		
8	9	8	7	24	199		1
9	9	8	7	23	222		
10	10	9	7	26	248	1	1
<b>Total</b>				<b>248</b>	<b>4</b>	<b>10</b>	

Archer

Marqueur



concours qualificatif salle octobre 2024  
salle des archers de Boé, 31-10-2024



Archer: **Pichayrou-Laforgue Celine**

**14B**

Clubs / Pays: **BOE - BOE/Fr**

**CO S2F**

18m-2	1	2	3	Départ: 1			
				Somme	Tot.	10	9
1	10	9	8	27		1	1
2	10	10	9	29	56	2	1
3	9	9	8	26	82		2
4	9	8	8	25	107		1
5	9	9	9	27	134		3
6	10	9	8	27	161	1	1
7	9	9	6	24	185		2
8	9	-	-	9	194		1
9	9	9	8	26	220		2
10	10	9	6	25	245	1	1
<b>Total</b>				<b>245</b>	<b>5</b>	<b>15</b>	

Archer

Marqueur



concours qualificatif salle octobre 2024  
salle des archers de Boé, 31-10-2024



Archer: **Meric Guy**

**1A**

Clubs / Pays: **MARMANDE - MARMANDE /fr**

**CL S3H**

18m-1	1	2	3	Départ: 2			
				Somme	Tot.	10	9
1	9	8	7	24			1
2	8	8	7	23	47		
3	10	9	7	26	73	1	1
4	10	10	7	27	100	2	
5	10	9	8	27	127	1	1
6	M	8	8	14	141		
7	9	9	8	26	167	2	2
8	8	8	7	23	192		
9	9	9	9	27	219		3
10	9	8	6	23	240		1
<b>Total</b>				<b>240</b>		<b>4</b>	<b>9</b>

Archer

Marqueur



concours qualificatif salle octobre 2024  
salle des archers de Boé, 31-10-2024



Archer: **Coppola Matheo**

**1B**

Clubs / Pays: **BOE - BOE/Fr**

**CL U13H**

18m-1	1	2	3	Départ: 2			
				Somme	Tot.	10	9
1	8	6	6	20			
2	8	5	4	17	37		
3	8	8	6	22	59		
4	8	8	7	23	82		
5	10	8	8	26	108	1	
6	9	6	5	20	128		1
7	9	8	7	24	152		1
8	6	6	5	17	169		
9	8	6	6	22	191		
10	7	5	1	13	204		
<b>Total</b>				<b>204</b>		<b>1</b>	<b>2</b>

Archer

Marqueur





Archer: **Meric Guy**

**1A**

Clubs / Pays: **MARMANDE - MARMANDE /fr**

**CL S3H**

18m-2	1	2	3	Départ: 2			
				Somme	Tot.	10	9
1	5	8	7	23			
2	9	9	4	22	45		2
3	9	8	6	23	68		1
4	9	9	9	27	95		3
5	9	7	6	22	117		1
6	10	10	6	26	143	2	1
7	9	8	8	25	168		1
8	10	9	7	26	194	1	1
9	10	8	7	26	220	1	
10	10	10	8	28	248	2	
<b>Total</b>				<b>248</b>	<b>6</b>	<b>9</b>	

Archer

Marqueur



Archer: **Coppola Matheo**

**1B**

Clubs / Pays: **BOE - BOE/Fr**

**CL U13H**

18m-2	1	2	3	Départ: 2			
				Somme	Tot.	10	9
1	9	8	5	22			1
2	10	8	2	20	42	1	
3	7	7	7	21	63		
4	9	9	1	19	82		2
5	9	8	19	17	99		1
6	9	8	5	22	121		1
7	8	8	8	24	145		
8	9	9	6	24	169		2
9	8	7	4	20	189		
10	10	8	7	25	214	1	
<b>Total</b>				<b>214</b>	<b>2</b>	<b>7</b>	

Archer

Marqueur



**concours qualificatif salle octobre 2024**  
salle des archers de Boé, 31-10-2024



Archer: **Jagu-Sabathier Mael**

**2A**

Clubs / Pays: BOE - BOE/Fr

CL U13H

18m-1	1	2	3	Départ: 2			
				Somme	Tot.	10	9
1	9	8	7	24	/	1	1
2	10	9	9	28	52	1	2
3	10	9	8	27	79	1	1
4	9	7	5	21	100	1	1
5	10	9	9	28	128	1	2
6	10	9	8	27	155	1	1
7	9	9	8	26	181	1	2
8	9	8	7	24	205	1	1
9	9	9	5	23	228	1	2
10	10	9	7	26	254	1	1
				Total	254	5	14

0040650K-CL-U13H-1



Archer



Marqueur



**concours qualificatif salle octobre 2024**  
salle des archers de Boé, 31-10-2024



Archer: **Cedo Ruben**

**2B**

Clubs / Pays: BOE - BOE/Fr

CL U13H

18m-1	1	2	3	Départ: 2			
				Somme	Tot.	10	9
1	9	9	8	26	/	1	2
2	9	9	8	26	52	1	2
3	10	9	8	27	79	1	1
4	9	9	9	27	106	1	3
5	9	9	8	26	132	1	2
6	10	10	9	29	161	2	2
7	10	9	7	26	187	2	1
8	10	10	9	29	216	2	1
9	10	9	8	27	243	2	1
10	10	8	8	26	269	1	1
				Total	269	8	14

0015023E-CL-U13H-1



Archer



Marqueur



Archer: **Jagu-Sabathier Mael**

**2A**

Clubs / Pays: BOE - BOE/Fr

CL U13H

18m-2	1	2	3	Départ: 2			
				Somme	Tot.	10	9
1	9	8	8	25	/	1	1
2	<del>9</del>	<del>8</del>	8	25	50	1	1
3	10	9	8	27	77	1	1
4	9	9	8	26	103	1	2
5	9	8	7	24	127	1	1
6	8	8	7	23	150	1	1
7	9	9	6	24	174	1	2
8	9	8	7	24	198	1	1
9	9	9	9	27	225	1	3
10	10	7	7	24	250	1	1
<b>Total</b>				<b>250</b>	<b>2</b>	<b>12</b>	

Archer

Marqueur



Archer: **Cedo Ruben**

**2B**

Clubs / Pays: BOE - BOE/Fr

CL U13H

18m-2	1	2	3	Départ: 2			
				Somme	Tot.	10	9
1	10	9	8	27	/	1	1
2	9	8	8	25	52	1	1
3	10	9	8	27	79	1	1
4	9	9	8	26	105	1	2
5	10	9	9	28	133	1	2
6	10	10	10	30	163	3	1
7	10	10	8	28	191	2	1
8	10	9	8	27	218	1	1
9	9	9	9	27	245	1	3
10	10	9	9	28	273	1	2
<b>Total</b>				<b>273</b>	<b>10</b>	<b>13</b>	

Archer

Marqueur







concours qualificatif salle octobre 2024  
salle des archers de Boé, 31-10-2024



Archer: **Morillas Capucine**

Clubs / Pays: BOE - BOE/Fr

**3A**  
CL U13F

18m-2	1	2	3	Départ: 2			
				Somme	Tot.	10	9
1	10	10	8	28		2	
2	9	9	9	27	55		3
3	10	9	7	26	81	1	1
4	9	9	6	24	105		
5	9	9	7	25	130		2
6	9	9	7	25	155		2
7	10	10	9	29	184	2	1
8	9	9	8	26	210		2
9	10	9	9	28	238	1	2
10	10	10	6	26	264		
<b>Total</b>				<b>264</b>	<b>6</b>	<b>13</b>	

Archer

Marqueur



concours qualificatif salle octobre 2024  
salle des archers de Boé, 31-10-2024



Archer: **Vignerte Jean**

Clubs / Pays: STE MAURE - Ste Maure De Peyriac/Fr

**3B**  
BB S1H

18m-2	1	2	3	Départ: 2			
				Somme	Tot.	10	9
1	10	10	8	28		2	
2	10	9	8	27	55	1	1
3	9	8	7	24	79		1
4	7	7	6	20	99		
5	10	9	7	26	125	1	1
6	10	9	8	27	152	1	1
7	10	8	8	26	178	1	
8	9	8	6	23	201		1
9	9	9	7	25	226		2
10	9	9	8	26	252		2
<b>Total</b>				<b>252</b>	<b>6</b>	<b>9</b>	

Archer

Marqueur





Archer: **Morillas Capucine**

**3A**

Clubs / Pays: **BOE - BOE/Fr**

**CL U13F**

18m-1	1	2	3	Départ: 2			
				Somme	Tot.	10	9
1	9	9	8	26			2
2	9	8	7	24	50		1
3	10	9	9	28	78	1	2
4	10	9	9	28	106	1	2
5	9	9	9	27	133		3
6	10	8	6	24	157	1	
7	9	8	8	25	182		1
8	9	8	8	25	207		1
9	10	10	7	27	234	2	
10	10	10	9	29	263	2	
				<b>Total</b>	263	7	12

0064626W-CL-U13F-1

  
 Archer

  
 Marqueur



Archer: **Vignerte Jean**

**3B**

Clubs / Pays: **STE MAURE - Ste Maure De Peyriac/Fr**

**CL S3H**

18m-1	1	2	3	Départ: 2			
				Somme	Tot.	10	9
1	9	8	8	25			1
2	10	8	7	25	50	1	
3	9	8	4	21	71		1
4	10	8	8	26	97	1	
5	8	8	7	23	120		
6	9	9	7	25	145		2
7	9	8	7	24	169		1
8	10	9	8	27	196	1	1
9	8	7	6	21	217		
10	10	7	7	24	241	1	
				<b>Total</b>	241	4	6

0021987Z-CL-S3H-1

  
 Archer

  
 Marqueur





concours qualificatif salle octobre 2024  
salle des archers de Boé, 31-10-2024



Archer: **Galli Eloise**

**4A**

Clubs / Pays: **BOE - BOE/Fr**

**CL U15F**

18m-1	1	2	3	Départ: 2			
				Somme	Tot.	10	9
1	9	8	8	25	25		1
2	10	8	8	26	51	1	
3	8	8	5	21	72		
4	8	8	6	22	94		
5	9	8	5	22	116		1
6	9	9	4	22	138		2
7	10	8	7	25	163	1	
8	9	8	7	24	187		1
9	10	9	7	26	213	1	1
10	10	6	3	19	232	1	
Total				232	46		

0031984R-CL-U15F-1

Archer

Marqueur



concours qualificatif salle octobre 2024  
salle des archers de Boé, 31-10-2024



Archer: **Eymerie Eric**

**4B**

Clubs / Pays: **MARMANDE - MARMANDE /fr**

**BB S1H**

18m-1	1	2	3	Départ: 2			
				Somme	Tot.	10	9
1	8	8	7	23	23		
2	8	8	8	24	47		
3	9	9	4	22	69		2
4	9	8	7	24	93		1
5	9	9	8	26	119		2
6	10	9	8	27	146	1	1
7	9	8	8	25	171		1
8	10	9	6	25	196	1	1
9	10	9	8	27	223	1	1
10	10	10	8	28	251	2	
Total				251	59		

0685368R-BB-S1H-1

Archer

Marqueur



Archer: **Galli Eloise**

**4A**

Clubs / Pays: BOE - BOE/Fr

CL U15F

18m-2	1	2	3	Départ: 2			
				Somme	Tot.	10	9
1	10	9	7	26	26	1	1
2	10	9	5	24	50	1	1
3	8	8	7	23	73		
4	8	8	7	23	96		
5	8	7	5	20	116		
6	9	5	5	19	135		1
7	9	7	7	23	158		1
8	9	8	4	21	179		1
9	7	6	5	18	197		
10	9	8	7	24	221		1
<b>Total</b>				<b>221</b>	<b>29</b>		

Archer

Marqueur



Archer: **Eymerie Eric**

**4B**

Clubs / Pays: MARMANDE - MARMANDE /fr

BB S1H

18m-2	1	2	3	Départ: 2			
				Somme	Tot.	10	9
1	9	8	7	24	24		1
2	10	8	7	25	49	1	
3	10	10	6	26	75	2	
4	10	8	8	26	101	1	
5	8	7	6	21	122		
6	8	6	6	20	142		
7	9	9	7	25	167		2
8	8	6	5	19	186		
9	9	5	2	16	201		
10	9	8	8	25	226		1
<b>Total</b>				<b>226</b>	<b>94</b>		

Archer

Marqueur



Archer: **De Flaujac Mayeul**

**5A**

Clubs / Pays: **BOE - BOE/Fr**

**CL U15H**

18m-2	1	2	3	Départ: 2			
				Somme	Tot.	10	9
1	10	9	9	28		1	2
2	10	9	6	25	53	1	1
3	10	10	9	29	82	2	1
4	9	9	8	26	108		2
5	10	8	8	26	134	1	
6	10	<del>7</del>	6	23	157	1	
7	9	8	7	24	181		1
8	10	10	9	29	210	2	1
9	10	10	8	28	238	2	
10	10	9	9	28	266	1	2
<b>Total</b>				<b>266</b>	<b>11</b>	<b>10</b>	

6/3

*Mayeul*  
 Archer

*Mayeul*  
 Marqueur



Archer: **Cornaglia Frédéric**

**5B**

Clubs / Pays: **MARMANDE - MARMANDE /fr**

**BB S1H**

18m-2	1	2	3	Départ: 2			
				Somme	Tot.	10	9
1	8	8	5	21			
2	10	7	7	24	45	1	
3	9	8	8	25	70		1
4	10	8	8	26	96	1	
5	9	8	7	24	120		1
6	8	8	8	24	144		
7	9	8	6	21	165		1
8	9	8	2	19	184		1
9	8	7	7	22	206		
10	10	9	4	23	229	1	1
<b>Total</b>				<b>229</b>	<b>3</b>	<b>5</b>	

*Cornaglia*  
 Archer

*Mayeul*  
 Marqueur



concours qualificatif salle octobre 2024  
salle des archers de Boé, 31-10-2024



Archer: **De Flaujac Mayeul**

**5A**

Clubs / Pays: **BOE - BOE/Fr**

**CL U15H**

18m-1	1	2	3	Départ: 2			
				Somme	Tot.	10	9
1	10	10	9	29		2	1
2	10	10	7	27	56	2	
3	10	9	7	26	82	1	1
4	9	8	8	25	107		1
5	9	7	7	23	130		1
6	9	9	8	26	156		2
7	9	9	9	27	183		3
8	10	10	9	29	212	2	1
9	9	9	8	26	238		2
10	10	9	9	28	266	1	2
				<b>Total</b>	<b>266</b>	<b>8</b>	<b>14</b>

0042998M-CL-U15H-1

*Mayeul*  
Archer

*De Flaujac*  
Marqueur



concours qualificatif salle octobre 2024  
salle des archers de Boé, 31-10-2024



Archer: **Cornaggia Frédéric**

**5B**

Clubs / Pays: **MARMANDE - MARMANDE /fr**

**BB S1H**

18m-1	1	2	3	Départ: 2			
				Somme	Tot.	10	9
1	10	8	5	23		1	
2	7	6	5	18	41		
3	10	9	9	28	69	1	2
4	7	7	5	19	88		
5	10	9	7	26	114	1	1
6	9	9	9	27	141		3
7	8	8	7	23	164		
8	9	5	7	21	178		1
9	8	7	6	21	199		
10	9	9	6	24	223	2	
				<b>Total</b>	<b>223</b>	<b>5</b>	<b>7</b>

1006324M-BB-S1H-1

*Cornaggia*  
Archer

*Mayeul*  
Marqueur





concours qualificatif salle octobre 2024  
salle des archers de Boé, 31-10-2024



Archer: **Ivora Axel**

**6A**

Clubs / Pays: BOE - BOE/Fr

CL U11H

18m-1	1	2	3	Départ: 2			
				Somme	Tot.	10	9
1	6	5	M	11			
2	7	6	5	18	29		
3	8	8	5	21	50		
4	7	5	4	16	66		
5	9	8	5	22	88		1
6	9	7	3	19	107		1
7	5	2	M	7	114		
8	7	7	4	18	132		
9	6	3	M	9	141		
10	9	6	1	16	157		1
Total				157			3

0047558U-CL-U11H-1

Archer

Marqueur



concours qualificatif salle octobre 2024  
salle des archers de Boé, 31-10-2024



Archer: **Sensamat Timeo**

**6B**

Clubs / Pays: BOE - BOE/Fr

CL U11H

18m-1	1	2	3	Départ: 2			
				Somme	Tot.	10	9
1	9	8	7	24			1
2	9	8	8	25	49		1
3	9	9	8	26	<del>68</del> 75		2
4	8	7	6	21	96		
5	8	8	7	23	119		
6	9	9	8	26	145		2
7	10	9	7	26	171	1	1
8	9	9	8	26	197		2
9	5	9	7	25	222		2
10	8	8	6	22	244		
Total				244		1	11

0017220T-CL-U11H-1

Archer

Marqueur





**concours qualificatif salle octobre 2024**  
salle des archers de Boé, 31-10-2024



Archer: **Ivora Axel**

**6A**

Clubs / Pays: BOE - BOE/Fr

CL U11H

18m-2	1	2	3	Départ: 2			
				Somme	Tot.	10	9
1	6	5	4	15	15		
2	4	4	3	11	26		
3	5	2	1	7	33		
4	5	8	2	15	52	1	
5	7	7	2	16	68		
6	10	8	4	22	90	1	
7	6	3	1	10	99		
8	5	4	1	10	113		1
9	6	4	1	11	124		
10	7	6	3	16	140		
<b>Total</b>				140	12		

Archer

Marqueur



**concours qualificatif salle octobre 2024**  
salle des archers de Boé, 31-10-2024



Archer: **Sensamat Timeo**

**6B**

Clubs / Pays: BOE - BOE/Fr

CL U11H

18m-2	1	2	3	Départ: 2			
				Somme	Tot.	10	9
1	9	9	8	27	27		3
2	10	9	6	25	52	1	1
3	10	9	8	27	79	1	1
4	10	8	7	25	104	1	
5	9	7	7	23	127		1
6	9	8	7	24	151		1
7	10	9	7	26	177	1	1
8	8	8	6	22	199		
9	9	9	8	26	225		2
10	9	8	6	23	248		
<b>Total</b>				248	4	10	

Archer

Marqueur





concours qualificatif salle octobre 2024  
salle des archers de Boé, 31-10-2024



Archer: **Lopez Oscar**

**7A**

Clubs / Pays: BOE - BOE/Fr

CL U15H

18m-1	1	2	3	Départ: 2			
				Somme	Tot.	10	9
1	10	9	9	28	.	1	2
2	10	9	9	28	56	1	2
3	10	9	9	28	84	1	2
4	10	10	9	29	113	2	1
5	10	10	9	29	142	2	1
6	10	10	9	29	171	2	1
7	10	9	9	28	199	1	2
8	10	10	10	30	229	3	
9	10	10	10	30	259	3	
10	10	10	9	29	288	2	1
Total				288		18	12



0992327S-CL-U15H-1

Archer

Marqueur



concours qualificatif salle octobre 2024  
salle des archers de Boé, 31-10-2024



Archer: **Aranda Joseph**

**7B**

Clubs / Pays: FRONTON - FRONTON/Fr

CL S3H

18m-1	1	2	3	Départ: 2			
				Somme	Tot.	10	9
1	9	6	M	15			1
2	4	2	2	8	23		
3	9	7	4	20	43		1
4	10	5	2	17	60	1	
5	9	8	7	24	84		1
6	10	7	3	20	104	1	
7	9	7	M	16	120		1
8	8	6	2	16	136		
9	8	7	7	22	158		
10	6	5	4	15	173		
Total				173		2	4



1008551D-CL-S3H-1

Archer

Marqueur





concours qualificatif salle octobre 2024  
salle des archers de Boé, 31-10-2024



Archer: **Escolano Charlyne**

**8A**

Clubs / Pays: BOE - BOE/Fr

CO S1F

18m-1	1	2	3	Départ: 2			
				Somme	Tot.	10	9
1	10	9	9	28	-	1	2
2	10	9	9	28	56	1	2
3	10	10	9	29	85	2	1
4	10	10	9	29	114	2	1
5	10	10	9	29	143	2	1
6	10	9	9	28	171	1	2
7	10	9	9	28	199	1	2
8	10	10	10	30	229	3	-
9	10	10	9	29	258	2	1
10	9	9	9	27	285	-	3
Total				285	15	15	

0763526V-CO-S1F-1

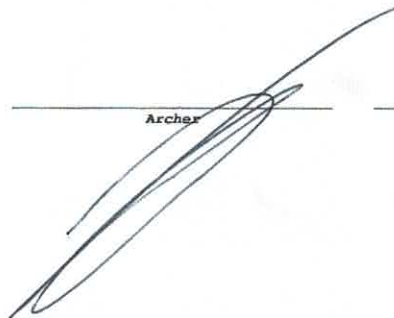
Archer: 

Marqueur: 



concours qualificatif salle octobre 2024  
salle des archers de Boé, 31-10-2024



Archer: **Nicolas Adrien**

**8B**

Clubs / Pays: NEUILLY - NEUILLY SUR MARNE/Fr

CO S1H

18m-1	1	2	3	Départ: 2			
				Somme	Tot.	10	9
1	10	10	9	29	-	2	1
2	10	10	10	30	59	3	-
3	10	10	10	30	89	3	-
4	10	9	9	28	117	1	2
5	10	9	9	28	145	1	2
6	10	9	9	28	173	1	2
7	10	9	9	28	201	1	2
8	10	9	9	28	229	1	2
9	10	10	10	30	259	2	-
10	10	9	9	28	287	1	2
Total				287	17	13	

0938041K-CO-S1H-1

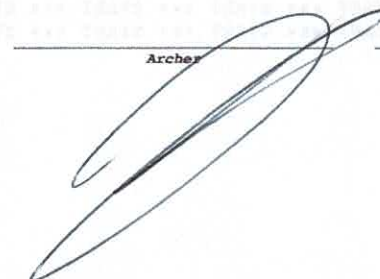

Archer: 

Marqueur: 



concours qualificatif salle octobre 2024  
salle des archers de Boé, 31-10-2024



Archer: **Escolano Charlyne**

**8A**

Clubs / Pays: BOE - BOE/Fr

CO S1F

18m-2	1	2	3	Départ: 2			
				Somme	Tot.	10	9
1	10	10	9	29	-	2	1
2	10	10	8	28	57	2	-
3	10	10	8	28	85	2	-
4	9	9	9	27	112	-	3
5	10	9	9	28	140	1	2
6	10	9	9	28	168	1	2
7	9	9	9	27	195	-	3
8	9	9	9	27	222	-	3
9	9	9	9	27	249	-	3
10	10	9	9	28	277	1	2
Total				277	90	18	

Archer

Marqueur



concours qualificatif salle octobre 2024  
salle des archers de Boé, 31-10-2024



Archer: **Nicolas Adrien**

**8B**

Clubs / Pays: NEUILLY - NEUILLY SUR MARNE/Fr

CO S1H

18m-2	1	2	3	Départ: 2			
				Somme	Tot.	10	9
1	10	10	10	30	-	3	
2	10	10	9	29	59	2	1
3	10	10	10	30	89	3	-
4	10	10	10	30	119	-	3
5	10	10	9	29	148	2	1
6	10	10	9	29	177	2	1
7	10	10	10	30	207	3	-
8	10	9	9	28	235	1	2
9	10	9	9	28	263	1	2
10	10	10	10	30	293	3	-
Total				293	23	7	

Archer

Marqueur



**concours qualificatif salle octobre 2024**  
salle des archers de Boé, 31-10-2024



Archer: **Cedo Julie**

Clubs / Pays: BOE - BOE/Fr

**9A**

CL U18F

18m-1	1	2	3	Départ: 2			
				Somme	Tot.	10	9
1	6	9	7	22		1	1
2	6	7	2	15	45	1	
3	6	9	7	22	71	1	1
4	6	9	9	24	99	1	2
5	6	7	5	18	121	1	
6	9	8	7	24	145		1
7	6	6	8	20	171	2	
8	9	9	6	24	195		2
9	9	9	6	24	219		2
10	6	9	8	22	246	1	1
<b>Total</b>				246	810		



0936713S-CL-U18F-1

Archer

Marqueur



**concours qualificatif salle octobre 2024**  
salle des archers de Boé, 31-10-2024



Archer: **Pinsard Thierry**

Clubs / Pays: ST MARTIN - ST MARTIN D ARMAGNAC/Fr

**9B**

CO S3H

18m-1	1	2	3	Départ: 2			
				Somme	Tot.	10	9
1	9	9	9	27			3
2	9	9	9	27	54		3
3	6	9	8	23	81	1	1
4	6	9	9	24	109	1	2
5	9	9	9	27	136		3
6	9	9	9	27	163		3
7	9	9	8	26	189		2
8	9	9	8	26	215		2
9	9	9	9	27	242		3
10	6	9	9	24	270	1	1
<b>Total</b>				270	323		



0870293W-CO-S3H-1

Archer

Marqueur



**concours qualificatif salle octobre 2024**  
salle des archers de Boé, 31-10-2024



Archer: **Cedo Julie**

**9A**

Clubs / Pays: **BOE - BOE/Fr**

**CL U18F**

18m-2	1	2	3	Départ: 2			
				Somme	Tot.	10	9
1	8	7	6	21			
2	9	8	5	22	43		1
3	8	7	7	22	65		
4	10	9	7	26	91	1	1
5	9	8	6	23	114		1
6	9	8	8	25	139		1
7	6	9	7	26	165	1	1
8	9	9	5	23	188		2
9	10	8	7	25	213	1	
10	9	9	8	26	239		2
<b>Total</b>				<b>239</b>	<b>3</b>	<b>9</b>	

Archer

Marqueur



**concours qualificatif salle octobre 2024**  
salle des archers de Boé, 31-10-2024



Archer: **Pinsard Thierry**

**9B**

Clubs / Pays: **ST MARTIN - ST MARTIN D ARMAGNAC/Fr**

**CO S3H**

18m-2	1	2	3	Départ: 2			
				Somme	Tot.	10	9
1	10	9	8	27		1	1
2	9	9	9	27	54		3
3	10	9	8	27	81	1	1
4	9	9	9	27	108		3
5	10	9	8	27	135	1	1
6	10	9	9	28	163	1	2
7	10	10	9	29	192	2	1
8	10	9	9	28	220	1	2
9	10	<del>10</del>	9	28	248	2	1
10	9	9	9	27	275		3
<b>Total</b>				<b>276</b>	<b>9</b>	<b>18</b>	

Archer

Marqueur

*628*



concours qualificatif salle octobre 2024  
salle des archers de Boé, 31-10-2024



Archer: **Sirben Elorri**

**10A**

Clubs / Pays: BOE - BOE/Fr

CL U21F

18m-2	1	2	3	Départ: 2			
				Somme	Tot.	10	9
1	9	9	7	25			2
2	9	8	8	25	50		1
3	10	9	8	27	77	1	1
4	10	9	9	28	105	1	2
5	8	8	6	22	127		
6	10	9	7	26	153	1	1
7	9	9	7	25	178		2
8	10	8	3	21	199	1	
9	7	7	6	20	219		
10	9	8	9	25	244		1
<b>Total</b>				<b>244</b>	<b>4</b>	<b>10</b>	

Archer

Marqueur



concours qualificatif salle octobre 2024  
salle des archers de Boé, 31-10-2024



Archer: **Roland Jean Pierre**

**10B**

Clubs / Pays: TOMBEBOEUF - Tombeboeuf/ Fr

CO S3H

18m-2	1	2	3	Départ: 2			
				Somme	Tot.	10	9
1	10	9	8	27		1	1
2	10	9	9	28	55	1	2
3	10	9	9	28	83	1	2
4	10	10	10	30	113	3	
5	10	9	9	28	141	1	2
6	10	10	9	29	170	2	1
7	9	9	8	26	196		2
8	10	10	10	30	226	3	
9	10	9	9	28	254	1	2
10	9	9	9	27	281		3
<b>Total</b>				<b>281</b>	<b>13</b>	<b>15</b>	

Archer

Marqueur





concours qualificatif salle octobre 2024  
salle des archers de Boé, 31-10-2024



Archer: **Sirben Elorri**

**10A**

Clubs / Pays: BOE - BOE/Fr

CL U21F

18m-1	1	2	3	Départ: 2			
				Somme	Tot.	10	9
1	10	9	8	27		1	1
2	10	8	7	25	52	1	
3	9	7	5	21	73		1
4	10	7	6	23	96	1	
5	10	8	7	25	121	1	
6	9	9	8	26	147		2
7	9	9	7	25	172		2
8	8	8	7	23	195		
9	9	8	6	23	218		1
10	9	8	7	24	242		1
				<b>Total</b>	<b>242</b>	<b>4</b>	<b>8</b>

0026838X-CL-U21F-1

Archer

Marqueur



concours qualificatif salle octobre 2024  
salle des archers de Boé, 31-10-2024



Archer: **Roland Jean Pierre**

**10B**

Clubs / Pays: TOMBEBOEUF - Tombeboeuf/ Fr

CO S3H

18m-1	1	2	3	Départ: 2			
				Somme	Tot.	10	9
1	10	9	9	28		1	2
2	9	9	9	27	55		3
3	10	10	8	28	83	2	
4	10	9	9	28	111	1	2
5	10	10	9	29	140	2	1
6	9	9	9	27	167		3
7	9	9	9	27	194		3
8	9	9	8	26	220		2
9	10	9	9	28	248	1	2
10	9	9	9	26	274		2
				<b>Total</b>	<b>274</b>	<b>7</b>	<b>20</b>

0031048Y-CO-S3H-1

Archer

Marqueur





concours qualificatif salle octobre 2024  
salle des archers de Boé, 31-10-2024



Archer: **Sarroste Victor**

**11A**

Clubs / Pays: RUELLE - RUELLE/Fr

CO S1H

18m-1	1	2	3	Départ: 2			
				Somme	Tot.	10	9
1	10	10	10	30		3	
2	10	10	10	30	60	3	
3	10	10	9	29	89	2	1
4	10	10	9	29	118	2	1
5	10	10	10	30	148	3	
6	10	10	9	29	177	2	1
7	10	10	9	29	206	2	1
8	10	10	9	29	235	2	1
9	10	10	10	30	265	3	
10	10	10	10	30	295	3	
				<b>Total</b>	<b>295</b>	<b>25</b>	<b>5</b>

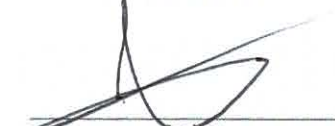

0710273L-CO-S1H-1

  
Archer

  
Marqueur



concours qualificatif salle octobre 2024  
salle des archers de Boé, 31-10-2024



Archer: **Cadeillan Noel**

**11B**

Clubs / Pays: SAMATAN - SAMATAN/Fr

CO S3H

18m-1	1	2	3	Départ: 2			
				Somme	Tot.	10	9
1	10	9	9	28		1	2
2	10	10	10	30	58	3	
3	10	10	10	30	88	3	
4	10	9	9	28	116	1	2
5	10	10	9	29	145	2	1
6	10	10	9	29	174	2	1
7	10	10	9	29	203	2	1
8	10	9	9	28	231	1	2
9	10	10	9	29	260	2	1
10	10	9	9	28	288	1	2
				<b>Total</b>	<b>288</b>	<b>18</b>	<b>12</b>

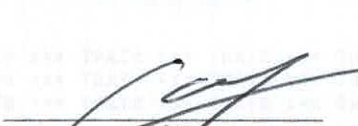

0261294R-CO-S3H-1

  
Archer

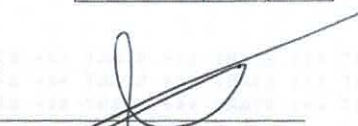
  
Marqueur





**concours qualificatif salle octobre 2024**  
salle des archers de Boé, 31-10-2024



Archer: **Sarrosse Victor**

**11A**

Clubs / Pays: RUELLE - RUELLE/Fr

CO S1H

18m-2	1	2	3	Départ: 2			
				Somme	Tot.	10	9
1	10	10	10	30		3	
2	10	9	9	28	58	1	2
3	9	9	9	27	85		3
4	10	10	9	29	114	2	1
5	10	10	9	29	143	2	1
6	10	10	10	30	173	3	
7	10	10	10	30	203	3	
8	10	10	9	29	232	2	1
9	10	10	9	29	261	2	1
10	10	10	10	30	291	3	
<b>Total</b>				<b>291</b>	<b>219</b>		

Archer

Marqueur



**concours qualificatif salle octobre 2024**  
salle des archers de Boé, 31-10-2024



Archer: **Cadeillan Noel**

**11B**

Clubs / Pays: SAMATAN - SAMATAN/Fr

CO S3H

18m-2	1	2	3	Départ: 2			
				Somme	Tot.	10	9
1	10	10	10	30		5	
2	10	10	10	30	60	3	
3	10	9	9	28	88	1	2
4	10	9	9	28	116	1	2
5	10	9	9	28	144	1	2
6	10	9	9	28	172	1	2
7	10	10	9	29	201	2	1
8	10	9	8	27	228	1	1
9	10	10	9	29	257	2	1
10	10	9	9	28	285	5	2
<b>Total</b>				<b>285</b>	<b>1613</b>		

Archer

Marqueur



**concours qualificatif salle octobre 2024**  
salle des archers de Boé, 31-10-2024



Archer: **Laforgue Yvon**

**12A**

Clubs / Pays: BOE - BOE/Fr

CL U18H

18m-1	1	2	3	Départ: 2			
				Somme	Tot.	10	9
1	9	9	M	18	18		2
2	10	9	8	27	45	1	1
3	10	9	M	19	64	1	1
4	9	7	6	22	86		1
5	8	6	M	14	100		
6	9	7	6	22	122		1
7	7	6	M	13	135		
8	9	8	M	17	152		1
9	9	8	7	24	176		1
10	9	8	M	17	193		1
				<b>Total</b>		2	9

0956074L-CL-U18H-1

Archer

Marqueur



**concours qualificatif salle octobre 2024**  
salle des archers de Boé, 31-10-2024



Archer: **Ordas Robert**

**12B**

Clubs / Pays: SAINE BAZ - Sainte bazeille/fr

CO S3H

18m-1	1	2	3	Départ: 2			
				Somme	Tot.	10	9
1	9	9	7	25	25		
2	10	9	7	26	51		
3	9	9	8	26	77		
4	9	9	6	24	101		
5	9	9	9	27	128		
6	9	8	8	25	153		
7	10	9	8	27	180		
8	9	9	9	27	207		
9	10	9	8	27	234		
10	10	9	7	26	260		
				<b>Total</b>		260	4 17

1006928S-CO-S3H-1

Archer

Marqueur

Archers concours qualificatif salle octobre 2024  
salle des archers de Boé, 31-10-2024



Archer: **Laforgue Yvon**

**12A**

Clubs / Pays: BOE - BOE/Fr

CL U18H

18m-2	1	2	3	Départ: 2			
				Somme	Tot.	10	9
1	10	10	9	29	29	2	1
2	10	7	11	17	46	1	
3	9	9	7	25	71		2
4	10	8	7	25	96	1	
5	10	9	11	19	115	1	1
6	10	10	9	29	144	2	1
7	10	6	6	22	166	1	
8	10	9	11	19	185	1	1
9	10	9	8	27	212	1	1
10	9	9	7	25	237		2
<b>Total</b>				<b>237</b>	<b>10</b>	<b>9</b>	

Archer

Marqueur

Archers concours qualificatif salle octobre 2024  
salle des archers de Boé, 31-10-2024



Archer: **Ordas Robert**

**12B**

Clubs / Pays: SAINTE BAZ - Sainte bazeille/fr

CO S3H

18m-2	1	2	3	Départ: 2			
				Somme	Tot.	10	9
1	9	9	6	24	24		2
2	9	8	8	25	49		1
3	9	9	8	26	75		2
4	9	8	7	24	99		1
5	9	9	8	26	125		2
6	9	8	7	24	149		1
7	9	9	8	26	175		2
8	10	9	8	27	202	1	1
9	9	9	9	27	229		3
10	9	9	8	26	255		2
<b>Total</b>				<b>255</b>	<b>1</b>	<b>16</b>	

Archer

Marqueur





Archer: **Nicolas Olivier**

**13A**

Clubs / Pays: AUCH - Auch/fr

CO S2H

18m-2	1	2	3	Départ: 2			
				Somme	Tot.	10	9
1	9	9	9	27	\	1	3
2	10	10	9	29	56	2	1
3	10	10	9	29	85	2	1
4	10	9	9	28	113	1	2
5	10	10	9	29	142	2	1
6	10	9	9	28	170	1	2
7	10	10	9	29	199	2	1
8	9	9	9	27	226	\	3
9	9	9	9	27	253	1	3
10	10	10	10	30	283	3	1
<b>Total</b>				<b>283</b>	<b>13</b>	<b>17</b>	

  
Archer

  
Marqueur



Archer: **Braak Poinot Azilys**

**13B**

Clubs / Pays: BOE - BOE/Fr

CL U18F

18m-2	1	2	3	Départ: 2			
				Somme	Tot.	10	9
1	9	7	6	22	\	\	1
2	9	9	8	26	48	\	2
3	9	9	7	25	73	\	2
4	10	9	6	25	98	1	1
5	9	8	8	25	123	\	1
6	9	9	8	26	149	\	2
7	9	8	7	24	173	\	1
8	10	10	8	28	201	2	1
9	10	9	8	27	228	1	1
10	10	10	7	27	255	2	\
<b>Total</b>				<b>255</b>	<b>6</b>	<b>11</b>	

  
Archer

  
Marqueur





Archer: **Nicolas Olivier**

Clubs / Pays: AUCH - Auch/fr

**13A**

CO S2H

18m-1	1	2	3	Départ: 2			
				Somme	Tot.	10	9
1	10	10	9	29	\	2	1
2	10	10	9	29	58	2	1
3	10	10	9	29	87	2	1
4	10	9	9	28	115	1	2
5	10	9	9	28	143	1	2
6	10	9	9	28	171	1	2
7	10	9	9	28	199	1	2
8	9	9	9	27	226	\	3
9	10	10	9	29	255	2	1
10	9	9	9	27	282	\	3
Total				282		12	18

0974349A-CO-S2H-1

Archer

Marqueur



Archer: **Braak Poinot Azilyls**

Clubs / Pays: BOE - BOE/Fr

**13B**

CL U18F

18m-1	1	2	3	Départ: 2			
				Somme	Tot.	10	9
1	10	9	8	27	\	1	1
2	9	9	6	24	51	\	2
3	10	9	9	28	79	1	2
4	10	9	5	24	103	1	1
5	9	8	8	25	128	\	1
6	9	9	9	27	155	\	3
7	8	8	8	25	180	\	1
8	9	8	6	23	203	\	1
9	8	7	4	19	222	\	\
10	9	9	8	26	248	\	2
Total				248		9	14

0020786U-CL-U18F-1

Archer

Marqueur



concours qualificatif salle octobre 2024  
salle des archers de Boé, 31-10-2024



Archer: **Dumont Aurelien**

**14A**

Clubs / Pays: BOE - BOE/Fr

CL U21H

18m-1	1	2	3	Départ: 2			
				Somme	Tot.	10	9
1	10	9	9	28		1	2
2	9	9	8	26	54		2
3	10	10	9	29	83	2	
4	10	9	8	27	110	1	1
5	10	10	9	29	139	2	1
6	10	9	9	28	167	1	2
7	10	8	7	25	192	1	
8	10	10	9	29	221	2	1
9	9	9	9	27	248		3
10	10	9	7	26	267	1	1
				<b>Total</b>	267	11	13



0923945N-CL-U21H-1

*[Signature]*  
Archer

*[Signature]*  
Marqueur



concours qualificatif salle octobre 2024  
salle des archers de Boé, 31-10-2024



Archer: **Marsias Lionel**

**14B**

Clubs / Pays: BERGERAC - BERGERAC/Fr

CL S2H

18m-1	1	2	3	Départ: 2			
				Somme	Tot.	10	9
1	9	7	7	23			1
2	9	8	1	18	41		1
3	9	8	7	24	58		1
4	10	9	6	25	83	1	1
5	10	10	7	27	110	2	
6	8	6	4	18	128		
7	9	8	7	24	152		1
8	9	8	6	23	175		1
9	10	9	8	27	202	1	1
10	10	8	7	25	227	1	
				<b>Total</b>	227	5	7



0799138D-CL-S2H-1

*[Signature]*  
Archer

*[Signature]*  
Marqueur



**concours qualificatif salle octobre 2024**  
salle des archers de Boé, 31-10-2024



Archer: **Dumont Aurelien**

**14A**

Clubs / Pays: **BOE - BOE/Fr**

**CL U21H**

18m-2	1	2	3	Départ: 2			
				Somme	Tot.	10	9
1	10	10	9	29		2	1
2	10	10	9	29	58	2	1
3	9	9	8	26	84		2
4	10	10	9	29	113	2	1
5	10	10	8	28	141	2	
6	10	9	9	28	169	2	2
7	10	9	7	19	188	1	1
8	10	10	10	30	218	3	
9	10	10	8	28	246	2	
10	10	10	10	30	276	3	
<b>Total</b>				<b>276</b>	<b>188</b>		

  
Archer

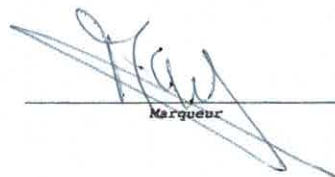
  
Marqueur



**concours qualificatif salle octobre 2024**  
salle des archers de Boé, 31-10-2024



Archer: **Marsias Lionel**

**14B**

Clubs / Pays: **BERGERAC - BERGERAC/Fr**

**CL S2H**

18m-2	1	2	3	Départ: 2			
				Somme	Tot.	10	9
1	9	8	8	25			1
2	9	7	7	23	48		1
3	8	8	8	24	72		
4	<del>9</del>	9	7	25	97		2
5	8	8	8	24	121		
6	9	9	5	23	144		2
7	9	8	7	24	161		1
8	10	8	8	26	187	1	
9	9	8	5	22	209		1
10	10	8	6	24	233	1	
<b>Total</b>				<b>233</b>	<b>208</b>		

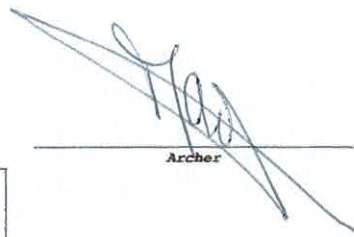
  
Archer

  
Marqueur

concouers qualificatif salle octobre 2024  
salle des archers de Boé, 31-10-2024



Archer: **Berger Valerie**

Clubs / Pays: STE MAURE - Ste Marie De Poitiers Fr

**2A**

BB S1F

18m-1	Somme			Départ: 3		
	1	2	3	Tot.	10	9
1	8	6	1	15		
2	9	5	3	17	32	1
3	9	7	2	18	50	1
4	6	3	3	12	62	
5	9	8	5	22	84	1
6	7	7	4	18	102	
7	X	6	4	20	122	1
8	10	9	7	26	148	1
9	10	8	3	21	169	1
10	10	7	5	22	191	1
<b>Total</b>				<b>191</b>	<b>4</b>	<b>4</b>

Archer

Marqueur



concouers qualificatif salle octobre 2024  
salle des archers de Boé, 31-10-2024



Archer: **Merle Romy**

Clubs / Pays: BOE- BOE/FR

**2B**

CL S1F

18m-1	Somme			Départ: 3		
	1	2	3	Tot.	10	9
1	8	7	6	24		
2	10	7	2	19	43	1
3	9	7	5	21	64	1
4	10	9	6	25	89	1
5	8	6	6	20	109	
6	7	7	6	20	129	
7	9	7	5	21	150	1
8	8	8	4	20	170	
9	6	6	5	17	187	
10	8	8	4	20	207	
<b>Total</b>				<b>207</b>	<b>2</b>	<b>3</b>

Archer

Marqueur

concouers qualificatif salle octobre 2024  
salle des archers de Boé, 31-10-2024



Archer: **Roumegas Leslie**

Clubs / Pays: BOE- BOE/FR

**2C**

CL U18F

18m-1	Somme			Départ: 3		
	1	2	3	Tot.	10	9
1	5	4	4	13		
2	10	7	3	20	33	1
3	5	4	3	12	45	
4	7	7	4	18	63	
5	7	6	5	18	81	
6	9	8	7	24	105	1
7	8	4	3	15	120	
8	9	4	5	18	138	1
9	8	7	6	21	159	
10	8	7	5	20	179	1
<b>Total</b>				<b>179</b>	<b>1</b>	<b>2</b>

Archer

Marqueur

concouers qualificatif salle octobre 2024  
salle des archers de Boé, 31-10-2024



Archer:

Clubs / Pays:

**2D**

18m-1	Somme			Départ: 3		
	1	2	3	Tot.	10	9
1						
2						
3						
4						
5						
6						
7						
8						
9						
10						
<b>Total</b>						

Archer

Marqueur



concours qualificatif salle octobre 2024  
salle des archers de Boé, 31-10-2024

401

Archer: **Berger Valerie**

Clubs / Pays: STE MAURE - Ste Maure De Poitou/Fr

2A

BB S1F

18m-2	Somme			Départ: 3	
	1	2	3		10
1	9	7	4	20	1
2	10	7	6	23	1
3	7	6	4	17	
4	8	7	7	22	
5	6	5	5	16	
6	10	8	7	25	1
7	9	9	2	20	2
8	8	6	5	19	
9	8	7	7	22	
10	10	9	7	26	1
Total				200	34

*[Signature]*  
Archer

*[Signature]*  
Margueur



concours qualificatif salle octobre 2024  
salle des archers de Boé, 31-10-2024

307

Archer: **Merle Romy**

Clubs / Pays: BOE - BOE/Fr

2B

CL S1F

18m-2	Somme			Départ: 3	
	1	2	3		10
1	9	7	6	23	1
2	10	8	3	21	1
3	8	6	6	20	
4	8	5	5	18	
5	8	7	7	15	
6	8	6	3	17	
7	8	8	7	23	
8	7	6	7	13	
9	9	6	4	19	1
10	8	8	5	21	
Total				190	12

*[Signature]*  
Archer

*[Signature]*  
Margueur

concours qualificatif salle octobre 2024  
salle des archers de Boé, 31-10-2024

374

Archer: **Roumegas Leslie**

Clubs / Pays: BOE - BOE/Fr

2C

CL U18F

18m-2	Somme			Départ: 3	
	1	2	3		10
1	10	2	0	12	1
2	7	7	6	20	
3	X	7	5	23	1
4	9	6	6	20	
5	10	6	4	20	1
6	8	6	5	19	
7	9	7	4	20	1
8	10	9	4	23	1
9	10	6	3	19	1
10	8	7	4	19	
Total				195	3

Archer

Margueur

concours qualificatif salle octobre 2024  
salle des archers de Boé, 31-10-2024

2D

Archer:

Clubs / Pays:

18m-2	Somme			Départ: 3	
	1	2	3		10
1					
2					
3					
4					
5					
6					
7					
8					
9					
10					
Total					

Archer

Margueur



Archer: **Dos Santos Vieira Josefina**

**3A**

Clubs / Pays: **MARMANDE - MARMANDE.fr**

CL S1F

18m-1	Somme			Départ: 3
	1	2	3	
1	10	9	7	1
2	10	9	8	1
3	8	6	5	1
4	8	6	4	1
5	10	9	7	1
6	9	7	6	1
7	9	9	6	2
8	9	7	6	1
9	9	7	5	1
10	9	9	7	2
<b>Total</b>			<b>230</b>	<b>3</b>

*[Handwritten signature]*  
 Archer

Archer

Marqueur



Archer: **Perier Anaïs**

**3B**

Clubs / Pays: **BOE- BOE/FR**

CL S1F

18m-1	Somme			Départ: 3
	1	2	3	
1				
2				
3				
4				
5				
6				
7				
8				
9				
10				
<b>Total</b>				

Archer

Marqueur



Archer: **Gely Brigitte**

**3C**

Clubs / Pays: **VILLEFRANC - VILLEFRANCE DE LONGMITH**

CL S3F

18m-1	Somme			Départ: 3
	1	2	3	
1	9	9	9	2
2	10	7	6	1
3	9	9	8	2
4	9	8	5	1
5	9	8	7	1
6	10	9	8	1
7	9	8	7	1
8	10	9	9	2
9	7	7	6	1
10	9	7	6	1
<b>Total</b>			<b>262</b>	<b>3</b>

*[Handwritten signature]*  
 Archer

Archer

Marqueur



Archer:

**3D**

Clubs / Pays:

18m-1	Somme			Départ: 3
	1	2	3	
1				
2				
3				
4				
5				
6				
7				
8				
9				
10				
<b>Total</b>				

Archer

Marqueur



Archer: **Dos Santos Vieira Josefina**

**3A**

Clubs / Pays: **MARMAUDE - MARMAUDE /fr**

CL S1F

18m-2	Somme			Départ: 3
	1	2	3	
1	8	8	7	23
2	8	7	6	21
3	10	9	7	26
4	9	8	5	22
5	8	8	5	21
6	10	8	7	25
7	8	8	5	21
8	9	4	4	17
9	10	10	8	28
10	10	8	8	26
<b>Total</b>				<b>230</b>

*[Signature]*  
 Archer

*[Signature]*  
 Margueur



Archer: **Perier Anaïs**

**3B**

Clubs / Pays: **BOE - BOE/FR**

CL S1F

18m-2	Somme			Départ: 3
	1	2	3	
1				
2				
3				
4				
5				
6				
7				
8				
9				
10				
<b>Total</b>				

Archer

Margueur



Archer: **Gely Brigitte**

**3C**

Clubs / Pays: **VILLEFRANC - ILEFRANCE DE LOUENAY**

CL S3F

18m-2	Somme			Départ: 3
	1	2	3	
1	7	6	6	19
2	9	7	4	20
3	10	9	5	24
4	10	8	5	23
5	10	10	8	28
6	8	8	7	23
7	10	6	6	22
8	10	9	9	28
9	9	8	8	25
10	9	9	6	24
<b>Total</b>				<b>236</b>

*[Signature]*  
 Archer

*[Signature]*  
 Margueur



Archer:

**3D**

Clubs / Pays:

18m-2	Somme			Départ: 3
	1	2	3	
1				
2				
3				
4				
5				
6				
7				
8				
9				
10				
<b>Total</b>				

Archer

Margueur



Archer: **Couvreur Claire**

**4A**

Clubs / Pays: **VILLENEUVE - Villeneuve Sur Lotfr**

CL S2F

18m-1	Somme			Départ: 3
	1	2	3	
1	9	8	8	1
2	9	8	7	1
3	9	9	8	2
4	10	9	9	2
5	9	9	8	2
6	9	8	7	1
7	10	10	9	2
8	9	9	9	3
9	10	8	6	1
10	10	9	7	1
<b>Total</b>				<b>5 14</b>

*Couvreur Claire*  
Archer



Archer

Archer

Archer



Archer: **Deleuze Carole**

**4C**

Clubs / Pays: **CASTELSAR - CASTELSARRASINFR**

CL S2F

18m-1	Somme			Départ: 3
	1	2	3	
1	9	8	7	1
2	8	8	4	4
3	8	8	4	6
4	7	7	5	8
5	9	9	8	2
6	9	9	7	2
7	8	6	3	1
8	8	7	4	1
9	9	8	6	1
10	9	5	5	1
<b>Total</b>				<b>6 7</b>

*Deleuze Carole*  
Archer

Archer

Archer

Archer

Archer: **Lacombe Caroline**

**4B**

Clubs / Pays: **BOE - BOEIF**

CL S2F

18m-1	Somme			Départ: 3
	1	2	3	
1	10	7	7	1
2	9	8	7	1
3	8	8	7	1
4	8	8	8	1
5	10	9	7	1
6	10	9	6	1
7	8	8	7	1
8	9	9	9	3
9	8	8	7	1
10	7	6	7	1
<b>Total</b>				<b>3 6</b>

*Lacombe Caroline*  
Archer

Archer

Archer

Archer

Archer

18m-1	Somme			Départ: 3
	1	2	3	
1				
2				
3				
4				
5				
6				
7				
8				
9				
10				
<b>Total</b>				

Archer

Archer

Archères  

**concours qualificatif salle octobre 2024**  
 salle des archers de Boé, 31-10-2024



Archer: **Couvreur Claire**

Clubs / Pays: **VILLENEUVE - Villeneuve Sur Luffr**

**4A**

CL S2F

18m-2	Somme			Départ: 3
	1	2	3	
1	10	9	9	2 1
2	9	7	6	1
3	9	9	7	1
4	9	9	7	2
5	10	10	8	2
6	7	6	6	2
7	10	10	8	2
8	10	8	7	1
9	10	8	7	1
10	10	9	8	1 1
<b>Total</b>			<b>250</b>	<b>9 6</b>

  
 Archer

Margueur

  
 Margueur



Archères  

**concours qualificatif salle octobre 2024**  
 salle des archers de Boé, 31-10-2024



Archer: **Deleuze Carole**

Clubs / Pays: **CASTELSAR - CASTELSARRASINIF**

**4C**

CL S2F

18m-2	Somme			Départ: 3
	1	2	3	
1	10	9	4	1 1
2	10	8	4	1
3	9	7	7	1
4	8	9	6	
5	8	8	6	
6	8	6	5	
7	8	6	5	
8	8	8	5	
9	10	7	3	1
10	9	8	2	1
<b>Total</b>			<b>210</b>	<b>3 3</b>

  
 Archer

Margueur

  
 Margueur

Archères  

**concours qualificatif salle octobre 2024**  
 salle des archers de Boé, 31-10-2024



Archer: **Lacombe Caroline**

Clubs / Pays: **BOE - BOE/FR**

**4B**

CL S2F

18m-2	Somme			Départ: 3
	1	2	3	
1	16	7	7	10 9
2	9	8	6	1
3	9	8	7	1
4	9	9	4	2
5	10	9	8	1 1
6	10	9	9	1 2
7	8	6	2	
8	9	6	6	1
9	9	9	8	2
10	9	8	4	1
<b>Total</b>			<b>236</b>	<b>3 11</b>

  
 Archer

Margueur

  
 Margueur

Archères  

**concours qualificatif salle octobre 2024**  
 salle des archers de Boé, 31-10-2024



Archer:

Clubs / Pays:

**4D**

18m-2	Somme			Départ: 3
	1	2	3	
1				10 9
2				
3				
4				
5				
6				
7				
8				
9				
10				
<b>Total</b>				

Margueur

Archer

concours qualificatif salle octobre 2024  
salle des archers de Boé, 31-10-2024



Archer: **Fenoul Sebastien**

Clubs / Pays: BOE - BOE/FR

**5A**

CL S2H

18m-1	1			2			3			Somme	Tot.	Départ: 3		
	10	9	8	10	9	8	10	9	8			10	9	8
1	10	9	9	10	9	9	10	9	9	27		1	1	
2	9	8	9	10	8	9	10	8	9	25	52			
3	9	9	9	10	9	9	10	9	9	27	79	3		
4	10	10	9	10	10	9	10	9	9	29	108	2	1	
5	10	9	9	10	9	9	10	9	9	27	136	1	2	
6	10	10	9	10	10	9	10	9	9	29	165	2	1	
7	10	10	10	10	10	10	10	10	10	30	195	3		
8	10	10	7	10	10	7	10	10	7	27	222	2		
9	10	8	7	10	8	7	10	8	7	25	247	1		
10	10	9	9	10	9	9	10	9	9	28	275	1	2	
<b>Total</b>										<b>275</b>	<b>1211</b>			

Archer

Marqueur



concours qualificatif salle octobre 2024  
salle des archers de Boé, 31-10-2024



Archer: **Peyrondet Francois**

Clubs / Pays: RUELLE - RUELLE/FR

**5C**

CO S2H

18m-1	1			2			3			Somme	Tot.	Départ: 3		
	10	9	8	10	9	8	10	9	8			10	9	8
1	9	9	9	10	9	9	10	9	9	27		3		
2	10	10	10	10	10	10	10	10	10	30	57	3		
3	10	10	9	10	10	9	10	10	9	29	86	2	1	
4	10	10	9	10	10	9	10	10	9	29	115	2	1	
5	10	9	9	10	9	9	10	9	9	28	143	1	2	
6	10	9	9	10	9	9	10	9	9	28	171	1	2	
7	10	10	10	10	10	10	10	10	10	30	201	3		
8	10	10	9	10	10	9	10	10	9	29	230	2	1	
9	10	10	9	10	10	9	10	10	9	29	259	2	1	
10	10	9	9	10	9	9	10	9	9	28	287	1	2	
<b>Total</b>										<b>287</b>	<b>1713</b>			

Archer

Marqueur

concours qualificatif salle octobre 2024  
salle des archers de Boé, 31-10-2024



Archer: **Roumegas Michael**

Clubs / Pays: BOE - BOE/FR

**5B**

CL S2H

18m-1	1			2			3			Somme	Tot.	Départ: 3		
	10	9	8	10	9	8	10	9	8			10	9	8
1	10	9	9	10	9	9	10	9	9	28		1	2	
2	10	10	9	10	10	9	10	10	9	29	57	2	1	
3	9	9	9	10	9	9	10	9	9	27	84	3		
4	10	10	9	10	10	9	10	10	9	29	113	2	1	
5	10	10	10	10	10	10	10	10	10	30	143	3		
6	10	10	9	10	10	9	10	10	9	29	172	2	1	
7	9	9	9	10	9	9	10	9	9	27	199	3		
8	9	9	9	10	9	9	10	9	9	27	226	3		
9	10	10	9	10	10	9	10	10	9	29	255	2	1	
10	10	9	9	10	9	9	10	9	9	28	283	1	2	
<b>Total</b>										<b>283</b>	<b>1717</b>			

Archer

Marqueur

concours qualificatif salle octobre 2024  
salle des archers de Boé, 31-10-2024



Archer:

Clubs / Pays:

**5D**

18m-1	1			2			3			Somme	Tot.	Départ: 3		
	10	9	8	10	9	8	10	9	8			10	9	8
1														
2														
3														
4														
5														
6														
7														
8														
9														
10														
<b>Total</b>														

Archer

Archer

Marqueur

Archevêque de Boé  
 concours qualificatif salle octobre 2024  
 salle des archers de Boé, 31-10-2024



Archer: **Fenoul Sebastien**

**5A**

Clubs / Pays: BOE - BOE/FR

CL S2H

18m-2	1			2			3			Somme	Tot.	Départ: 3		
	1	2	3	1	2	3	1	2	3			10	9	
1	10	9	9	9	28				28			1	2	
2	9	9	9	9	27				27				3	
3	10	10	10	10	30				30				3	
4	10	10	10	10	30				30				3	
5	10	10	10	10	30				30				3	
6	10	9	9	9	28				28			1	2	
7	10	10	8	8	28				28			2	2	
8	10	9	9	9	28				28			1	2	
9	10	10	7	7	27				27			2	2	
10	10	10	10	10	30				30			3	3	
<b>Total</b>					<b>286</b>				<b>286</b>			<b>19</b>	<b>9</b>	

*[Signature]*  
 Archer

*[Signature]*  
 Marqueur



Archer

Archer

Marqueur

Archevêque de Boé  
 concours qualificatif salle octobre 2024  
 salle des archers de Boé, 31-10-2024



Archer: **Roumegas Michael**

**5B**

Clubs / Pays: BOE - BOE/FR

CL S2H

18m-2	1			2			3			Somme	Tot.	Départ: 3		
	1	2	3	1	2	3	1	2	3			10	9	
1	10	9	9	9	28				28			1	2	
2	10	10	9	9	29				29			5	1	
3	10	10	10	10	30				30			8	7	
4	10	10	10	10	30				30			1	7	
5	10	10	9	9	29				29			1	4	
6	10	10	9	9	29				29			2	1	
7	10	10	8	8	28				28			2	3	
8	10	9	9	9	28				28			1	2	
9	10	9	8	8	27				27			1	1	
10	10	9	8	8	27				27			1	1	
<b>Total</b>					<b>285</b>				<b>285</b>			<b>17</b>	<b>8</b>	

*[Signature]*  
 Archer

*[Signature]*  
 Marqueur

Archevêque de Boé  
 concours qualificatif salle octobre 2024  
 salle des archers de Boé, 31-10-2024



Archer: **Peyrondet Francois**

**5C**

Clubs / Pays: RUELE - RUELE/FR

CO S2H

18m-2	1			2			3			Somme	Tot.	Départ: 3		
	1	2	3	1	2	3	1	2	3			10	9	
1	10	10	10	10	30				30			3		
2	10	9	9	9	28				28			5	2	
3	10	10	10	10	30				30			8	3	
4	10	9	9	9	28				28			1	2	
5	10	9	9	9	28				28			1	2	
6	10	10	9	9	29				29			2	1	
7	10	10	10	10	30				30			3	3	
8	10	10	9	9	29				29			2	1	
9	10	10	9	9	29				29			2	1	
10	10	10	9	9	29				29			2	1	
<b>Total</b>					<b>290</b>				<b>290</b>			<b>20</b>	<b>10</b>	

*[Signature]*  
 Archer

*[Signature]*  
 Marqueur

Archevêque de Boé  
 concours qualificatif salle octobre 2024  
 salle des archers de Boé, 31-10-2024



Archer:

**5D**

Clubs / Pays:

18m-2	1			2			3			Somme	Tot.	Départ: 3		
	1	2	3	1	2	3	1	2	3			10	9	
1														
2														
3														
4														
5														
6														
7														
8														
9														
10														
<b>Total</b>														

Archer

Marqueur

concoures qualificatif salle octobre 2024  
salle des archers de Boé, 31-10-2024



Archer: **Cazarré Jean-Francois**

Clubs / Pays: BOF. BOEIFR

**6A**

CL S1H

18m-1	Départ: 3			Somme	Tot.	Départ: 3			
	1	2	3			10	9		
1	10	9	4	26				1	1
2	10	9	8	27	53			1	1
3	10	9	9	29	80			3	
4	10	10	4	24	104			2	
5	9	9	9	27	134			3	
6	10	10	9	29	162			1	2
7	10	10	9	29	191			2	1
8	10	10	9	29	210			2	1
9	9	9	9	27	237			3	
10	10	10	9	29	266			1	1
<b>Total</b>				<b>186</b>	<b>1118</b>				

*Cazarré*  
Archer

Marqueur



concoures qualificatif salle octobre 2024  
salle des archers de Boé, 31-10-2024



Archer: **Nicolas Adrien**

Clubs / Pays: NEUILLY - NEUILLY SUR MARNEFR

**6C**

COS1H

18m-1	Départ: 3			Somme	Tot.	Départ: 3			
	1	2	3			10	9		
1	10	10	9	29				2	1
2	10	10	9	29	58				
3	10	9	9	28	86			1	2
4	10	10	10	30	116				
5	10	10	9	29	145			2	1
6	10	10	9	29	174			1	1
7	10	10	9	29	203			2	1
8	10	10	9	29	232			1	1
9	10	10	9	29	261			1	1
10	10	9	9	28	289			1	2
<b>Total</b>				<b>284</b>	<b>1014</b>				

*Nicolas*  
Archer

Marqueur

concoures qualificatif salle octobre 2024  
salle des archers de Boé, 31-10-2024



Archer: **Laforgue Hugo**

Clubs / Pays: BOE. BOEIFR

**6B**

CL S1H

18m-1	Départ: 3			Somme	Tot.	Départ: 3			
	1	2	3			10	9		
1	10	9	8	27				1	1
2	10	10	9	29	56			1	1
3	10	9	9	28	84			1	2
4	10	9	9	28	112			1	2
5	10	8	7	25	139			1	
6	10	10	10	30	169			3	
7	10	9	9	28	195			1	1
8	10	10	9	29	224			2	1
9	10	9	9	28	252			1	2
10	10	9	1	17	279			1	1
<b>Total</b>				<b>249</b>	<b>1114</b>				

*Laforgue*  
Archer

Marqueur

concoures qualificatif salle octobre 2024  
salle des archers de Boé, 31-10-2024



Archer: **Sarrosse Victor**

Clubs / Pays: RUELLE - RUELLE/FR

**6D**

COS1H

18m-1	Départ: 3			Somme	Tot.	Départ: 3			
	1	2	3			10	9		
1	10	9	9	28				2	2
2	10	10	9	29	57			2	1
3	10	10	9	29	86			2	1
4	10	10	9	29	115			2	1
5	9	9	9	27	142				1
6	10	9	9	28	170			1	2
7	10	9	9	28	198			1	2
8	10	10	10	30	228			3	
9	10	10	9	29	257			2	1
10	10	10	9	29	286			2	1
<b>Total</b>				<b>286</b>	<b>1164</b>				

*Sarrosse*  
Archer

Marqueur



concours qualificatif salle octobre 2024  
salle des archers de Boé, 31-10-2024



Archer: **Cazarré Jean-Francois**

Clubs / Pays: BOE - BOE/FR

**6A**

CL S1H

18m-2	1			2			3			Somme	Tot.	Départ: 3		
	1	2	3	1	2	3	1	2	3			10	9	
1	10	9	9	9	8	8	7	7	15	32	1	1	1	
2	10	9	8	8	8	8	7	7	32	32	1	1	1	
3	10	9	8	8	8	8	7	7	32	32	1	1	1	
4	10	9	8	8	8	8	7	7	32	32	1	1	1	
5	10	9	8	8	8	8	7	7	32	32	1	1	1	
6	10	9	8	8	8	8	7	7	32	32	1	1	1	
7	9	8	8	8	8	8	7	7	32	32	1	1	1	
8	8	7	7	7	7	7	6	6	34	34	1	1	1	
9	10	9	8	8	8	8	7	7	32	32	1	1	1	
10	10	9	8	8	8	8	7	7	32	32	1	1	1	
<b>Total</b>										160	8	8	8	

*Cazarré*  
Archer

*Archer*  
Marqueur



concours qualificatif salle octobre 2024  
salle des archers de Boé, 31-10-2024



Archer: **Laforgue Hugo**

Clubs / Pays: BOE - BOE/FR

**6B**

CL S1H

18m-2	1			2			3			Somme	Tot.	Départ: 3		
	1	2	3	1	2	3	1	2	3			10	9	
1	10	9	7	9	9	9	7	7	26	85	1	1	1	
2	10	10	9	9	9	9	8	8	29	83	1	1	1	
3	10	10	9	9	9	9	8	8	29	86	1	1	1	
4	10	10	9	9	9	9	8	8	29	86	1	1	1	
5	10	10	9	9	9	9	8	8	29	86	1	1	1	
6	10	9	9	9	9	9	8	8	27	81	1	1	1	
7	10	10	9	9	9	9	8	8	27	81	1	1	1	
8	10	9	9	9	9	9	8	8	27	81	1	1	1	
9	10	9	9	9	9	9	8	8	27	81	1	1	1	
10	10	10	9	9	9	9	8	8	29	87	1	1	1	
<b>Total</b>										279	15	15	15	

*Laforgue*  
Archer

*Archer*  
Marqueur

concours qualificatif salle octobre 2024  
salle des archers de Boé, 31-10-2024



Archer: **Nicolas Adrien**

Clubs / Pays: NEUILLY - NEUILLY SUR MARNEFR

**6C**

CO S1H

18m-2	1			2			3			Somme	Tot.	Départ: 3		
	1	2	3	1	2	3	1	2	3			10	9	
1	10	10	10	10	9	9	9	9	30	59	3	1	1	
2	10	10	9	9	9	9	8	8	30	69	3	1	1	
3	10	10	9	9	9	9	8	8	30	69	3	1	1	
4	10	10	9	9	9	9	8	8	30	69	3	1	1	
5	10	10	9	9	9	9	8	8	30	69	3	1	1	
6	10	10	9	9	9	9	8	8	30	69	3	1	1	
7	10	10	9	9	9	9	8	8	30	69	3	1	1	
8	10	10	9	9	9	9	8	8	30	69	3	1	1	
9	10	10	9	9	9	9	8	8	30	69	3	1	1	
10	10	10	9	9	9	9	8	8	30	69	3	1	1	
<b>Total</b>										249	15	15	15	

*Archer*  
Archer

*Archer*  
Marqueur

concours qualificatif salle octobre 2024  
salle des archers de Boé, 31-10-2024



Archer: **Sarroste Victor**

Clubs / Pays: RUELLE - RUELLE/FR

**6D**

CO S1H

18m-2	1			2			3			Somme	Tot.	Départ: 3		
	1	2	3	1	2	3	1	2	3			10	9	
1	9	9	9	9	9	9	8	8	27	56	3	1	1	
2	10	10	9	9	9	9	8	8	29	65	3	1	1	
3	10	10	9	9	9	9	8	8	29	65	3	1	1	
4	10	10	9	9	9	9	8	8	29	65	3	1	1	
5	10	10	9	9	9	9	8	8	29	65	3	1	1	
6	10	10	9	9	9	9	8	8	29	65	3	1	1	
7	10	10	9	9	9	9	8	8	29	65	3	1	1	
8	10	10	9	9	9	9	8	8	29	65	3	1	1	
9	10	10	9	9	9	9	8	8	29	65	3	1	1	
10	10	10	9	9	9	9	8	8	29	65	3	1	1	
<b>Total</b>										488	15	15	15	

*Archer*  
Archer

*Archer*  
Marqueur

concours qualificatif salle octobre 2024  
salle des archers de Boé, 31-10-2024



Archer: **Merle Mateo**

Clubs / Pays: BOE - BOE/FR

**7A**

CL U13H

18m-1	Somme			Départ: 3		
	1	2	3	Tot.	10	9
1	10	10	5	25	2	1
2	9	9	8	26	1	2
3	9	9	8	26	1	2
4	9	8	7	24	1	1
5	9	9	8	26	1	2
6	9	9	8	26	1	2
7	10	9	6	25	1	1
8	10	8	1	19	1	1
9	9	6	5	20	1	1
10	10	10	5	25	2	1
<b>Total</b>				<b>246</b>	<b>6</b>	<b>13</b>

Archer

Marqueur



concours qualificatif salle octobre 2024  
salle des archers de Boé, 31-10-2024



Archer: **Pontacq Serge**

Clubs / Pays: STE MAURE - Ste Maure De Poitiers

**7B**

BB S1H

18m-1	Somme			Départ: 3		
	1	2	3	Tot.	10	9
1	9	9	8	26	1	2
2	9	9	4	22	1	2
3	9	9	7	25	1	2
4	9	9	1	19	1	3
5	9	7	6	22	1	1
6	9	7	7	23	1	1
7	6	7	1	14	1	1
8	9	7	1	17	1	1
9	8	8	5	21	1	1
10	9	9	3	21	1	2
<b>Total</b>				<b>220</b>	<b>0</b>	<b>14</b>

Archer

Marqueur

concours qualificatif salle octobre 2024  
salle des archers de Boé, 31-10-2024



Archer: **Moreau Aigline**

Clubs / Pays: BOE - BOE/FR

**7C**

CL U18F

18m-1	Somme			Départ: 3		
	1	2	3	Tot.	10	9
1	10	9	8	27	1	1
2	10	9	8	27	1	1
3	10	9	7	26	1	1
4	10	9	8	27	1	1
5	9	9	9	27	1	2
6	9	8	8	25	1	3
7	9	9	9	27	1	1
8	10	9	8	27	1	1
9	9	9	8	26	1	2
10	9	9	8	26	1	2
<b>Total</b>				<b>264</b>	<b>6</b>	<b>13</b>

Archer

Marqueur

concours qualificatif salle octobre 2024  
salle des archers de Boé, 31-10-2024



Archer:

Clubs / Pays:

**7D**

18m-1	Somme			Départ: 3		
	1	2	3	Tot.	10	9
1						
2						
3						
4						
5						
6						
7						
8						
9						
10						
<b>Total</b>						

Archer

Marqueur

concours qualificatif salle octobre 2024  
salle des archers de Boé, 31-10-2024



concours qualificatif salle octobre 2024  
salle des archers de Boé, 31-10-2024



Archer: **Merle Mateo**

**7A**

Clubs / Pays: BOE - BOE/FR

CL U13H

18m-2	Somme			Départ: 3
	1	2	3	
1	10	9	9	10 9
2	9	7	7	1 1
3	9	9	7	1 2
4	9	9	4	1 2
5	10	9	8	1 1
6	10	9	7	1 1
7	10	10	9	2 1
8	10	9	7	1 1
9	9	9	8	1 2
10	9	9	5	1 2
<b>Total</b>				<b>255 6 A</b>

*Handwritten signature*

Archer

Marqueur



concours qualificatif salle octobre 2024  
salle des archers de Boé, 31-10-2024



concours qualificatif salle octobre 2024  
salle des archers de Boé, 31-10-2024



Archer: **Moreau Aigline**

**7C**

Clubs / Pays: BOE - BOE/FR

CL U18F

18m-2	Somme			Départ: 3
	1	2	3	
1	9	9	6	10 9
2	9	9	8	1 2
3	10	9	7	1 1
4	10	9	8	1 2
5	9	9	9	1 2
6	9	9	8	1 3
7	9	9	9	1 1
8	9	9	6	1 2
9	9	9	9	1 2
10	9	9	8	1 2
<b>Total</b>				<b>260 4 A</b>

Archer

Marqueur

Archer: **Pontacq Serge**

**7B**

Clubs / Pays: STE MAURE - Ste Maure de Pyriac/FR

BB S1H

18m-2	Somme			Départ: 3
	1	2	3	
1	9	8	5	10 9
2	9	8	7	1 1
3	9	7	5	1 1
4	9	7	6	1 1
5	10	9	8	1 1
6	9	5	5	1 1
7	8	8	5	1 1
8	9	8	6	1 1
9	9	8	3	1 1
10	8	8	2	1 1
<b>Total</b>				<b>210 15</b>

*Handwritten signature*

Archer

Marqueur

Archevêques de Boé  
 concours qualificatif salle octobre 2024  
 salle des archers de Boé, 31-10-2024



Archer: Bertossi Jean

8A

Clubs / Pays: BOE · BOE/Fr

CO S3H

18m-1	Départ: 3			Tot.
	1	2	3	
1	9	9	8	26
2	10	10	9	55
3	10	9	9	83
4	9	9	9	87
5	10	10	9	139
6	9	9	8	165
7	9	9	9	192
8	9	9	8	218
9	9	9	9	245
10	9	9	9	272
<b>Total</b>				<b>2745</b>

*[Signature]*  
 Archer

Marqueur

*[Signature]*



Archevêques de Boé  
 concours qualificatif salle octobre 2024  
 salle des archers de Boé, 31-10-2024



Archer: Duval Sylvère

8C

Clubs / Pays: VILLENEUVE · Villeneuve Sur Loir

CO S2H

18m-1	Départ: 3			Tot.
	1	2	3	
1	10	9	9	28
2	10	10	9	57
3	10	10	9	86
4	9	9	9	113
5	10	10	9	142
6	10	9	9	170
7	10	10	9	199
8	10	9	9	227
9	9	9	9	255
10	9	9	8	280
<b>Total</b>				<b>2801</b>

*[Signature]*  
 Archer

Marqueur

*[Signature]*

Archevêques de Boé  
 concours qualificatif salle octobre 2024  
 salle des archers de Boé, 31-10-2024



Archer: Lopez Oscar

8B

Clubs / Pays: BOE · BOE/Fr

CL U15H

18m-1	Départ: 3			Tot.
	1	2	3	
1	10	10	10	30
2	10	9	9	58
3	10	10	10	88
4	10	9	9	116
5	10	10	10	146
6	10	10	9	175
7	10	9	8	202
8	10	9	9	230
9	10	10	10	260
10	10	10	9	289
<b>Total</b>				<b>289</b>

*[Signature]*  
 Archer

Marqueur

*[Signature]*

Archevêques de Boé  
 concours qualificatif salle octobre 2024  
 salle des archers de Boé, 31-10-2024



Archer:

8D

Clubs / Pays:

18m-1	Départ: 3			Tot.
	1	2	3	
1				
2				
3				
4				
5				
6				
7				
8				
9				
10				
<b>Total</b>				

Marqueur

Archer

concours qualificatif salle octobre 2024  
salle des archers de Boé, 31-10-2024



concours qualificatif salle octobre 2024  
salle des archers de Boé, 31-10-2024



Archer: **Bertossi Jean**

**8A**

Archer: **Lopez Oscar**

**8B**

Clubs / Pays: BOE - BOE/FR

CO S3H

Clubs / Pays: BOE - BOE/FR

CL U15H

18m-2	Départ: 3			Tot.
	1	2	3	
1	10	10	8	28
2	9	9	9	27
3	9	9	9	27
4	9	9	8	26
5	10	9	8	27
6	9	9	9	27
7	9	8	7	24
8	9	9	8	26
9	10	9	9	28
10	9	9	8	26
<b>Total</b>				<b>266</b>

*[Signature]*  
Archer

Marqueur



Archer

Marqueur

concours qualificatif salle octobre 2024  
salle des archers de Boé, 31-10-2024



concours qualificatif salle octobre 2024  
salle des archers de Boé, 31-10-2024



Archer: **Duval Sylvère**

**8C**

Archer: \_\_\_\_\_

**8D**

Clubs / Pays: VILLENEUVE - Villeneuve Sur Lotfr

CO S2H

Clubs / Pays: \_\_\_\_\_

Clubs / Pays: \_\_\_\_\_

18m-2	Départ: 3			Tot.
	1	2	3	
1	9	9	9	28
2	10	10	9	29
3	10	10	9	29
4	10	9	9	28
5	9	9	9	27
6	10	9	9	28
7	9	9	17	18
8	10	10	9	29
9	10	10	9	29
10	10	9	9	29
<b>Total</b>				<b>272</b>

*[Signature]*  
Archer

Marqueur

18m-2	Départ: 3			Tot.
	1	2	3	
1				
2				
3				
4				
5				
6				
7				
8				
9				
10				
<b>Total</b>				<b>18</b>

Archer

Marqueur



Archer: **Gleyroux Theo**

Clubs / Pays: **MARMANDE - MARMANDE.fr**

**9A**

CO S1H

18m-1	Somme			Départ: 3
	1	2	3	
1	9	9	3	3
2	10	9	5	2
3	10	9	8	1
4	10	9	9	2
5	9	9	8	3
6	10	9	8	1
7	9	9	9	3
8	10	10	4	2
9	9	9	9	3
10	10	9	9	1
<b>Total</b>				<b>272</b>

Archer

*[Signature]*

Marqueur

*[Signature]*



Archer

*[Signature]*

Marqueur

*[Signature]*



Archer: **Le Bliguet Loic**

Clubs / Pays: **BOE - BOE/FR**

**9C**

CO S1H

18m-1	Somme			Départ: 3
	1	2	3	
1	10	10	10	3
2	10	9	9	1
3	10	10	9	2
4	10	10	9	2
5	10	9	9	1
6	10	10	9	2
7	10	9	9	1
8	10	10	9	2
9	10	9	9	1
10	10	10	9	2
<b>Total</b>				<b>286</b>

Archer

*[Signature]*

Marqueur

*[Signature]*



Archer: **Braak Poinsoz Azilys**

Clubs / Pays: **BOE - BOE/FR**

**9B**

CL U18F

18m-1	Somme			Départ: 3
	1	2	3	
1	8	6	6	9
2	10	8	7	1
3	9	8	7	1
4	10	8	6	1
5	9	9	8	0
6	X	8	6	1
7	9	8	7	1
8	<del>7</del> 7	7	6	1
9	8	8	6	1
10	7	6	6	1
<b>Total</b>				<b>228</b>

Archer

*[Signature]*

Marqueur

*[Signature]*



Archer: **Le Bliguet Loic**

Clubs / Pays: **BOE - BOE/FR**

**9D**

CO S1H

18m-1	Somme			Départ: 3
	1	2	3	
1				9
2				
3				
4				
5				
6				
7				
8				
9				
10				
<b>Total</b>				<b></b>

Archer

*[Signature]*

Marqueur

*[Signature]*

Archevêque de Boé  
 concours qualificatif salle octobre 2024  
 salle des archers de Boé, 31-10-2024



Archer: **Gleyroux Theo**

Clubs / Pays: **MARMANDE - MARMANDE.fr**

**9A**

CO S1H

18m-2	Somme			Départ: 3		
	1	2	3	Tot.	10	9
1	9	9	9	27		3
2	9	9	9	27	54	3
3	9	9	9	27	81	3
4	10	9	9	28	109	1 2
5	10	9	9	28	137	1 2
6	10	9	9	28	165	1 2
7	9	9	9	27	192	2
8	10	9	9	28	220	1 2
9	10	10	9	29	249	2 1
10	9	7	7	23	272	1
<b>Total</b>			<b>272</b>	<b>6</b>	<b>22</b>	

Archer

MARMANDE

*(Signature)*



Archer

MARQUEUR

*(Signature)*

Archevêque de Boé  
 concours qualificatif salle octobre 2024  
 salle des archers de Boé, 31-10-2024



Archer: **Braak Poinot Azilys**

Clubs / Pays: **BOE - BOE/FR**

**9B**

CL U18F

18m-2	Somme			Départ: 3		
	1	2	3	Tot.	10	9
1	7	6	6	19		
2	8	7	7	22	41	
3	9	6	5	20	61	1
4	10	9	8	27	88	1 1
5	9	8	7	24	112	1
6	9	9	8	27	139	1 1
7	9	8	6	23	162	1
8	8	8	8	24	186	
9	9	8	7	24	210	1
10	9	8	7	24	234	
<b>Total</b>			<b>234</b>	<b>2</b>	<b>6</b>	

Archevêque de Boé  
 concours qualificatif salle octobre 2024  
 salle des archers de Boé, 31-10-2024



Archer: **Le Bliguet Loic**

Clubs / Pays: **BOE - BOE/FR**

**9C**

CO S1H

18m-2	Somme			Départ: 3		
	1	2	3	Tot.	10	9
1	10	10	9	29		2 1
2	10	9	9	28	57	1 2
3	10	10	9	29	86	2 1
4	10	9	9	28	114	1 2
5	9	9	9	27	141	3
6	10	10	10	30	171	3 3
7	10	9	9	28	199	1 3
8	10	9	9	28	227	1 2
9	9	9	9	27	254	3
10	10	9	9	28	282	1 2
<b>Total</b>			<b>282</b>	<b>12</b>	<b>19</b>	

Archer

MARQUEUR

*(Signature)*

Archevêque de Boé  
 concours qualificatif salle octobre 2024  
 salle des archers de Boé, 31-10-2024



Archer:

Clubs / Pays:

**9D**

18m-2	Somme			Départ: 3		
	1	2	3	Tot.	10	9
1						
2						
3						
4						
5						
6						
7						
8						
9						
10						
<b>Total</b>						

Archer

MARQUEUR

*(Signature)*

concours qualificatif salle octobre 2024  
salle des archers de Boé, 31-10-2024



concours qualificatif salle octobre 2024  
salle des archers de Boé, 31-10-2024



Archer: **Filhastre Lucie**

**10A**

Clubs / Pays: BOE - BOE/FR

CL U18F

18m-1	Somme			Départ: 3		
	1	2	3	Tot.	10	9
1	10	9	8	27	27	11
2	10	9	8	27	54	11
3	10	9	8	27	81	11
4	10	9	9	28	109	12
5	10	10	9	29	138	21
6	9	9	8	26	164	22
7	10	10	10	30	194	31
8	10	9	9	28	222	22
9	10	9	9	28	250	22
10	9	9	9	27	277	23
<b>Total</b>				<b>277</b>	<b>1115</b>	

*[Signature]*  
Archer

*[Signature]*  
Marqueur



Archer: **Teyssevre Matthias**

**10B**

Clubs / Pays: MARMANDE - MARMANDE fr

CL U21H

18m-1	Somme			Départ: 3		
	1	2	3	Tot.	10	9
1	10	10	9	29	29	21
2	10	10	9	29	58	21
3	10	10	10	30	88	31
4	9	9	8	26	114	22
5	10	9	9	28	142	22
6	10	10	9	29	171	21
7	10	9	9	28	199	22
8	10	9	7	26	225	21
9	10	10	9	29	254	21
10	10	9	9	28	282	22
<b>Total</b>				<b>282</b>	<b>1512</b>	

*[Signature]*  
Archer

*[Signature]*  
Marqueur

concours qualificatif salle octobre 2024  
salle des archers de Boé, 31-10-2024



concours qualificatif salle octobre 2024  
salle des archers de Boé, 31-10-2024



Archer: **Deleuze Cyprien**

**10C**

Clubs / Pays: CASTELSAR - CASTELSARRASIN

CL U18H

18m-1	Somme			Départ: 3		
	1	2	3	Tot.	10	9
1	10	9	9	28	28	12
2	10	10	9	29	57	21
3	9	8	7	24	81	21
4	10	10	9	29	110	21
5	10	9	9	28	138	22
6	10	9	M	19	157	21
7	10	10	M	20	177	21
8	10	8	7	25	202	21
9	10	9	9	28	230	22
10	10	10	9	29	259	21
<b>Total</b>				<b>259</b>	<b>1131</b>	

*[Signature]*  
Archer

*[Signature]*  
Marqueur

Archer:

Clubs / Pays:

**10D**

18m-1	Somme			Départ: 3		
	1	2	3	Tot.	10	9
1						
2						
3						
4						
5						
6						
7						
8						
9						
10						
<b>Total</b>						

Archer

Marqueur





Archer: **Filhastre Lucie**

Clubs / Pays: BOE - BOE/FF

**10A**

CL U18F

18m-2	Somme			Départ: 3		
	1	2	3	Tot.	10	9
1	10	9	8	27	77	11
2	10	9	8	27	54	11
3	10	9	9	28	82	12
4	10	10	9	29	111	21
5	10	10	9	29	140	21
6	10	9	8	27	167	11
7	10	9	9	28	195	12
8	10	10	8	28	223	22
9	10	9	9	28	251	12
10	10	9	8	27	278	11
<b>Total</b>				<b>278</b>	<b>1312</b>	

*(Signature)*  
Archer

Marqueur



Archer

*(Signature)*

Marqueur

*(Signature)*



Archer: **Teysseire Matthias**

Clubs / Pays: MARMANDE - MARMANDE fr

**10B**

CL U21H

18m-2	Somme			Départ: 3		
	1	2	3	Tot.	10	9
1	10	0	9	28	78	12
2	10	10	10	30	58	32
3	10	9	9	28	86	12
4	10	10	10	30	116	32
5	10	10	9	29	145	21
6	10	10	9	29	174	21
7	10	9	9	28	202	12
8	9	9	8	26	228	12
9	10	9	8	27	253	12
10	10	10	8	28	281	22
<b>Total</b>				<b>281</b>	<b>1611</b>	

*(Signature)*  
Archer

Archer

*(Signature)*

Marqueur

*(Signature)*



Archer: **Deleuze Cyprien**

Clubs / Pays: CASTELSAR - CASTELSARRASINW

**10C**

CL U18H

18m-2	Somme			Départ: 3		
	1	2	3	Tot.	10	9
1	10	9	9	28	78	11
2	9	8	8	25	53	11
3	10	9	8	27	80	11
4	10	10	10	30	110	31
5	10	8	8	26	136	11
6	10	9	8	27	163	11
7	10	10	9	29	192	21
8	10	10	8	28	220	22
9	9	9	9	27	247	23
10	10	10	9	29	276	21
<b>Total</b>				<b>276</b>	<b>1310</b>	

*(Signature)*  
Archer

Archer

*(Signature)*

Marqueur



Archer:

Clubs / Pays:

**10D**

18m-2	Somme			Départ: 3		
	1	2	3	Tot.	10	9
1						
2						
3						
4						
5						
6						
7						
8						
9						
10						
<b>Total</b>						

*(Signature)*  
Archer

Archer

*(Signature)*

Marqueur

*(Signature)*

concours qualificatif salle octobre 2024  
salle des archers de Boé, 31-10-2024



Archer: **Roland Jean Pierre**

Clubs / Pays: **TOMBEBOEUF - Tomboboué Fr**

CO S3H

**11A**

Départ: 3

18m-1	Somme			Départ: 3		
	1	2	3	Tot.	10	9
1	10	9	9	28		1
2	10	9	9	28	56	1
3	10	9	9	28	84	1
4	10	9	8	27	111	1
5	9	9	9	27	138	3
6	10	9	9	28	166	1
7	9	9	9	27	193	3
8	10	10	9	29	222	1
9	10	9	9	28	250	1
10	10	9	9	28	278	1
<b>Total</b>				<b>278</b>	<b>920</b>	

Archer

Marqueur



concours qualificatif salle octobre 2024  
salle des archers de Boé, 31-10-2024



Archer: **Raymond Isabelle**

Clubs / Pays: **BOE - BOEIF**

CO S3F

**11B**

Départ: 3

18m-1	Somme			Départ: 3		
	1	2	3	Tot.	10	9
1	9	9	9	27		3
2	9	9	8	26	53	2
3	9	9	8	26	79	2
4	9	9	7	25	104	2
5	9	9	8	26	130	2
6	9	9	7	25	155	2
7	10	9	8	27	182	1
8	9	9	8	26	208	2
9	10	9	8	27	235	1
10	9	9	7	25	260	2
<b>Total</b>				<b>260</b>	<b>219</b>	

Archer

Marqueur

concours qualificatif salle octobre 2024  
salle des archers de Boé, 31-10-2024



Archer: **Fourcade Marie Christine**

Clubs / Pays: **BOE - BOEIF**

CO S3F

**11C**

Départ: 3

18m-1	Somme			Départ: 3		
	1	2	3	Tot.	10	9
1	10	9	8	27		1
2	9	8	8	25	52	1
3	9	9	7	25	77	2
4	9	9	8	26	103	2
5	9	9	7	25	128	2
6	10	10	8	28	156	2
7	10	10	9	29	185	1
8	9	9	9	27	212	3
9	9	9	8	26	238	2
10	10	9	9	28	266	1
<b>Total</b>				<b>266</b>	<b>616</b>	

Archer

Marqueur

concours qualificatif salle octobre 2024  
salle des archers de Boé, 31-10-2024



Archer:

Clubs / Pays:

**11D**

Départ: 3

18m-1	Somme			Départ: 3		
	1	2	3	Tot.	10	9
1						
2						
3						
4						
5						
6						
7						
8						
9						
10						
<b>Total</b>						

Archer

Marqueur

concours qualificatif salle octobre 2024  
salle des archers de Boé, 31-10-2024



concours qualificatif salle octobre 2024  
salle des archers de Boé, 31-10-2024



Archer: **Roland Jean Pierre**

**11A**

Clubs / Pays: TOMBEBOEUF - Tomboboeuff Fr

18m-2	CO S3H			Somme	Tot.	Départ: 3		
	1	2	3			10	9	9
1	10	9	9	28		1	2	1
2	10	10	9	29	57	2	1	2
3	<del>10</del>	9	8	26	83	2	2	2
4	10	9	9	28	111	1	2	2
5	10	9	8	27	138	1	1	1
6	10	9	9	28	166	1	2	2
7	9	9	9	27	193	1	3	3
8	10	10	9	29	222	2	1	1
9	10	9	8	27	249	1	1	1
10	9	9	9	27	276	3	3	3
<b>Total</b>				<b>276</b>	<b>918</b>			

Archer

Marqueur



concours qualificatif salle octobre 2024  
salle des archers de Boé, 31-10-2024

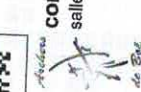

concours qualificatif salle octobre 2024  
salle des archers de Boé, 31-10-2024



Archer: **Fourcade Marie Christine**

**11C**

Clubs / Pays: BOE - BOE/FR

18m-2	CO S3F			Somme	Tot.	Départ: 3		
	1	2	3			10	9	9
1	9	9	8	26				2
2	9	9	9	27	53			3
3	9	9	9	27	80			3
4	10	10	7	27	107			2
5	9	9	8	26	133			2
6	9	9	M	18	151			2
7	9	8	8	25	176			1
8	10	9	9	28	204			1
9	9	9	8	26	230			2
10	10	9	9	28	258			2
<b>Total</b>				<b>258</b>	<b>419</b>			

Archer

Marqueur

Archer: **Raymond Isabelle**

Clubs / Pays: BOE - BOE/FR

**11B**

18m-2	CO S3F			Somme	Tot.	Départ: 3		
	1	2	3			10	9	9
1	10	9	9	28		1	2	1
2	10	9	9	28	56	1	2	2
3	10	9	M	19	75	1	1	1
4	9	9	9	27	102	1	3	3
5	9	9	9	27	129	1	3	3
6	10	9	7	26	155	1	1	1
7	9	9	8	26	181	1	2	2
8	10	10	8	28	209	2	2	2
9	9	9	8	26	235	2	2	2
10	10	9	M	19	254	1	1	1
<b>Total</b>				<b>254</b>	<b>717</b>			

Archer

Marqueur

**11D**

Clubs / Pays:

18m-2	CO S3F			Somme	Tot.	Départ: 3		
	1	2	3			10	9	9
1								
2								
3								
4								
5								
6								
7								
8								
9								
10								
<b>Total</b>								

Archer

Marqueur

concoure qualificatif salle octobre 2024  
salle des archers de Boé, 31-10-2024



Archer: **Decat Bernard**

Clubs / Pays: BOE • BOE/FR

**12A**

CO S3H

Départ: 3

18m-1	Clubs / Pays			Somme	Tot.
	1	2	3		
1					
2					
3					
4					
5					
6					
7					
8					
9					
10					
<b>Total</b>					

Archer

Marqueur

Archer



Marqueur

concoure qualificatif salle octobre 2024  
salle des archers de Boé, 31-10-2024



Archer: **Ollie Gabriel**

Clubs / Pays: BOE • BOE/FR

**12C**

CO S3H

Départ: 3

18m-1	Clubs / Pays			Somme	Tot.
	1	2	3		
1	9	9	9	27	27
2	9	8	8	25	52
3	10	9	7	26	78
4	9	9	7	25	103
5	9	9	9	27	130
6	9	9	7	25	155
7	9	8	7	24	179
8	9	9	8	25	204
9	9	9	7	25	229
10	9	8	6	23	252
<b>Total</b>					252

Archer

Marqueur

concoure qualificatif salle octobre 2024  
salle des archers de Boé, 31-10-2024



Archer: **Naudy Chantal**

Clubs / Pays: FRONTON • FRONTON/FR

**12B**

CO S3F

Départ: 3

18m-1	Clubs / Pays			Somme	Tot.
	1	2	3		
1	9	8	7	24	
2	10	9	9	29	53
3	9	8	8	26	79
4	9	9	7	26	105
5	9	9	8	26	131
6	9	9	8	26	157
7	9	8	6	23	180
8	9	9	9	27	207
9	9	7	7	23	230
10	9	9	6	24	254
<b>Total</b>					246

Archer

Clubs / Pays:

**12D**

18m-1	Clubs / Pays			Somme	Tot.
	1	2	3		
1					
2					
3					
4					
5					
6					
7					
8					
9					
10					
<b>Total</b>					

Archer

Marqueur

concours qualificatif salle octobre 2024  
salle des archers de Boé, 31-10-2024

Archer: **Decat Bernard**

Clubs / Pays: BOE - BOE/FR

**12A**

CO S3H

18m-2	Clubs / Pays			Somme	Départ: 3
	1	2	3		
1					
2					
3					
4					
5					
6					
7					
8					
9					
10					
<b>Total</b>					

Archer

Marqueur



concours qualificatif salle octobre 2024  
salle des archers de Boé, 31-10-2024

Archer: **Ollie Gabriel**

Clubs / Pays: BOE - BOE/FR

**12C**

CO S3H

18m-2	Clubs / Pays			Somme	Départ: 3
	1	2	3		
1	9	9	8	26	1
2	9	9	7	25	2
3	9	8	8	25	2
4	8	8	7	23	1
5	10	9	6	25	1
6	8	9	7	24	1
7	10	9	8	27	1
8	9	9	7	25	1
9	10	10	9	29	2
10	9	9	9	27	3
<b>Total</b>				233	13

Archer

Marqueur

concours qualificatif salle octobre 2024  
salle des archers de Boé, 31-10-2024

Archer: **Naudy Chantal**

Clubs / Pays: FRONTON - FRONTON/FR

**12B**

CO S3F

18m-2	Clubs / Pays			Somme	Départ: 3
	1	2	3		
1	10	8	6	24	1
2	10	9	8	27	1
3	10	9	9	28	1
4	10	9	9	28	2
5	9	9	7	25	2
6	10	10	9	29	2
7	10	9	8	27	1
8	9	9	8	26	1
9	9	8	7	24	2
10	9	9	7	25	1
<b>Total</b>				255	13

Archer

Marqueur

501 (20)

*[Handwritten signature]*

concours qualificatif salle octobre 2024  
salle des archers de Boé, 31-10-2024

Archer: **Ollie Gabriel**

Clubs / Pays: BOE - BOE/FR

**12D**

18m-2	Clubs / Pays			Somme	Départ: 3
	1	2	3		
1					
2					
3					
4					
5					
6					
7					
8					
9					
10					
<b>Total</b>					

Archer

Marqueur

*[Handwritten signature]*

concours qualificatif salle octobre 2024  
salle des archers de Boé, 31-10-2024



13A

CO S3H

Archer: **Pinsard Thierry**

Clubs / Pays: SAINT-MART

18m-1	Somme			Tot.	Départ: 3			
	1	2	3		10	9		
1	10	10	9	29			2	1
2	10	9	9	28			5	7
3	10	10	9	29			8	6
4	10	9	9	28			11	1
5	10	9	9	28			14	2
6	10	10	9	29			17	1
7	10	9	8	27			19	8
8	10	9	9	28			22	6
9	10	10	10	30			25	6
10	10	9	9	28			28	4
<b>Total</b>				<b>284</b>			<b>15</b>	<b>14</b>

Marqueur



Archer

*(Signature)*

concours qualificatif salle octobre 2024  
salle des archers de Boé, 31-10-2024



13B

CO S1H

Archer: **Dias Opiniao Kevin**

Clubs / Pays: BOE - BOE/FR

18m-1	Somme			Tot.	Départ: 3			
	1	2	3		10	9		
1	9	8	8	25			1	1
2	10	9	9	28			5	3
3	10	9	11	30			7	2
4	10	10	8	28			10	2
5	9	9	8	26			12	6
6	10	10	9	29			15	2
7	10	9	9	28			18	1
8	10	9	8	27			21	0
9	10	10	9	29			23	9
10	10	9	9	28			26	7
<b>Total</b>				<b>267</b>			<b>11</b>	<b>13</b>

Archer

Marqueur

*(Signature)*

concours qualificatif salle octobre 2024  
salle des archers de Boé, 31-10-2024



13C

CO S2H

Archer: **Nicolas Olivier**

Clubs / Pays: AUCH - Auch/fr

18m-1	Somme			Tot.	Départ: 3			
	1	2	3		10	9		
1	10	9	9	28			1	2
2	10	10	9	29			2	7
3	10	9	9	28			1	2
4	10	9	9	28			1	2
5	10	10	9	29			2	7
6	10	9	9	28			1	2
7	9	9	9	27			1	2
8	10	9	9	28			2	7
9	10	10	9	29			2	7
10	10	10	9	29			2	7
<b>Total</b>				<b>283</b>			<b>13</b>	<b>17</b>

Marqueur

Archer

*(Signature)*

concours qualificatif salle octobre 2024  
salle des archers de Boé, 31-10-2024



13D

Archer:

Clubs / Pays:

18m-1	Somme			Tot.	Départ: 3			
	1	2	3		10	9		
1								
2								
3								
4								
5								
6								
7								
8								
9								
10								
<b>Total</b>								

Marqueur

Archer

concours qualificatif salle octobre 2024  
salle des archers de Boé, 31-10-2024



Archer: **Pinsard Thierry**

Clubs / Pays: SAINT-MART -

**13A**

CO S3H

18m-2	Somme			Départ: 3
	1	2	3	
1	9	9	9	3
2	10	9	9	2
3	10	9	9	2
4	10	9	9	2
5	10	10	10	3
6	9	9	9	3
7	10	9	8	1
8	10	9	9	2
9	10	9	9	2
10	10	9	10	2
<b>Total</b>			<b>280</b>	<b>18</b>

Archer

Marqueur



Archer

Marqueur

concours qualificatif salle octobre 2024  
salle des archers de Boé, 31-10-2024



Archer: **Nicolas Olivier**

Clubs / Pays: AUCH - Auch/fr

**13B**

CO S2H

18m-2	Somme			Départ: 3
	1	2	3	
1	10	9	8	1
2	10	9	9	2
3	10	10	10	3
4	10	10	9	2
5	10	9	9	2
6	10	10	9	2
7	10	9	8	1
8	10	9	9	2
9	10	9	9	2
10	10	9	9	2
<b>Total</b>			<b>282</b>	<b>14</b>

concours qualificatif salle octobre 2024  
salle des archers de Boé, 31-10-2024



Archer: **Dias Opiniao Kevin**

Clubs / Pays: BOE - BOEFR

**13C**

COS1H

18m-2	Somme			Départ: 3
	1	2	3	
1	10	9	9	2
2	9	9	6	2
3	9	8	8	1
4	10	9	8	1
5	9	9	9	3
6	10	9	9	2
7	10	9	9	2
8	10	9	9	2
9	9	9	8	2
10	9	9	9	3
<b>Total</b>			<b>268</b>	<b>20</b>

Archer

Marqueur

concours qualificatif salle octobre 2024  
salle des archers de Boé, 31-10-2024



Archer:

Clubs / Pays:

**13D**

18m-2	Somme			Départ: 3
	1	2	3	
1				
2				
3				
4				
5				
6				
7				
8				
9				
10				
<b>Total</b>				

Archer

Marqueur